



EASTERN CAPE PROVINCE
DEPARTMENT OF EDUCATION
REQUEST FOR QUOTATION
FOR
PREFABRICATED STRUCTURE RELIEF PROGRAMME
TWO CLASSROOM BLOCK – SUPPLY AND ERECT
AMAZIZI SENIOR SECONDARY SCHOOL
EMIS NO: 200200017

DISTRICT: AMATHOLE WEST

RFQ NO : 2022/07/065

Consisting of:

Single Volume: The Request for Quotation (Returnable) - This document

BIDDER:

CRS NO:

Compiled for:

SUPPLY CHAIN MANAGEMENT
Eastern Cape Department of Education
Steve Tshwete Complex, Zone 6
ZWELITSHA
5608

Website: www.edu.ecprov.gov.za

Compiled by:

DEPARTMENT OF EDUCATION (DoE)
INFRASTRUCTURE DELIVERY
Eastern Cape Department of Education
Steve Tshwete Complex, Zone 6
ZWELITSHA
5608

SEPTEMBER 2022

PNO : 9007193

REQUEST FOR QUOTATION

Index

REQUEST FOR QUOTATION

Part 1: Bid Procedure

- T1.1 Request for Quotation Notice and Invitation to Bid (SBD1)
- T1.2 Request for Quotation Data

Part 2: Agreement and Contract Data

- C1.1 Form of Offer and Acceptance
- C1.1a Final Summary of Bills of Quantities
- C1.1b Standard Conditions of Tender
- C1.2 Contract Data
- C1.3 Form of Guarantee

Part 3: Returnable Schedules/Documents

1. T2.1 List of Returnable Documents
2. T2.2 Returnable Documents:
 - SBD 4 Declaration of Interest
 - SBD 6.1 Preference Points Claim Form in terms of the Preferential Procurement Regulations 2017
 - SBD 6.2 Local Production and Content
 - T2.2.1 Certificate of Authority for Signatory
 - T2.2.2 Certificate of Authority for Joint Ventures
 - T2.2.5 Record of Addenda to Request for Quotation Documents
 - T2.2.6 Capacity of Bidder
 - T2.2.7 Relevant Project Experience - Completed Projects
 - T2.2.8 Relevant Project Experience - Current Projects
 - T2.2.9 Schedule of Plant & Equipment
 - T2.2.10 Compulsory Enterprise Questionnaire
 - T2.2.11 CIDB Grading Certificate
 - T2.2.12 Other Certificates
 - T2.2.13 Completed Project Reference Forms

THE CONTRACT

Part 4: Scope of Work

- C3.1 Scope of work
- C3.2 Health and Safety Specification
- C3.4 Contractors Reports

Part 5: Pricing data

- C2.1 Pricing instructions
- C2.2 Preliminaries/Bill of Quantities/Final Summary
- C2.3 Prefab Specification Guideline T2.2W

Part 6: Site information

- C4 Site information
- C5 Drawings

Part 1: BID PROCEDURE

**T1.1: Request for Quotation Notice and Invitation to Bid
(SBD1)**



REQUEST FOR QUOTATION NOTICE

DEPARTMENT OF EDUCATION **EASTERN CAPE PROVINCE**

Bidders are hereby invited by **DoE** for the following contract, relating to the Prefabricated Structure Relief Programme for additional classroom facilities.

PREFABRICATED STRUCTURE RELIEF PROGRAMME: SUPPLY AND ERECT TWO CLASSROOM BLOCK AT AMAZIZI SENIOR SECONDARY SCHOOL

2022/07/065

[CIDB Grade: 2GB Category or Higher]

Principal Agent

Mr Q Msiwa

Tel: 040-608 4707

Project Leader (DoE)

Mr Q Msiwa

Tel: 040-608 4707

Request for Quotation documents will be available as from **12h00** on **14 September 2022** at the offices of the **Department of Education, Steve Tshwete Complex, Zone 6, Zwelitsha** or **Website <https://eceducation.gov.za/>**.

Completed Request for Quotation documents in a sealed envelope endorsed with the project name, request for quotation number and description must be deposited in the Tender Box, **Department of Education, Steve Tshwete Complex, Zone 6, Zwelitsha**, not later than **12h00** on **28 September 2022** when request for quotations will not be opened in public. The performance of the Contractor will be evaluated on a monthly basis and the overall performance report will be issued at the end of the project.

There will not be a pre-bid clarification meeting.

Bidders shall take note of the following Bid conditions –

- Single Volume to be submitted
- Priced BoQ to be submitted
- Bidders are required to have a CIDB contractor grading designation **2GB** or higher
- JV Agreements with installers and CIDB graded contractors would be acceptable.
- An approved surety will be required
- Penalties for late completion will be enforced
- Late request for quotations will not be accepted
- Letter of Good Standing from the Compensation Fund or FEMA to be submitted with request for quotation

- ❑ Failure to complete all supplementary information and the RETURNABLE SCHEDULES could result in the request for quotation being eliminated
- ❑ Preferential Procurement Regulations, 2011 (B-BBEE) principles will apply, whereby a Bidder's submission will be evaluated according to the sum of the Award of Points in respect of the Bid value and the status of the enterprise
- ❑ CIPRO/CIPC Certificate to be submitted with request for quotation
- ❑ Adjudication criteria are as follows:
 - ❑ **80** Points for Price
 - ❑ **20** Points for B-BBEE status level of Contribution

A CERTIFIED COPY OF A VALID B-BBEE VERIFICATION CERTIFICATE VERIFIED BY A SANAS APPROVED RATING AGENCY OR A SWORN AFFIDAVIT MUST BE SUBMITTED IN ORDER TO QUALIFY FOR PREFERENCE POINTS FOR B-BBEE. IN THE CASE OF A JOINT VENTURE BOTH ENTITIES SHOULD SUBMIT VALID SANAS APPROVED OR A SWORN AFIDAVIT CERTIFICATES WITH APPROPRIATE SPLIT BETWEEN ENTITIES (SIGNED BY ALL PARTIES).

- ❑ Request for quotation validity period is 120 (one hundred and twenty) calendar days
- ❑ Request for quotation forms (Form C1.1: Form of offer and acceptance) that are incomplete or incorrectly completed will result in elimination of that request for quotation
- ❑ An original valid SARS Tax Clearance Certificate/Pin must be submitted with the request for quotation, in order to be considered. Failure for submission of Tax Clearance Certificate will result in elimination of request for quotation. In the case of a JV, each partner must present an original SARS Tax Clearance Certificate
- ❑ Form T2.2r (Compulsory Enterprise Questionnaire) must be completed by all or the request for quotation will be eliminated
- ❑ In case of a joint venture a two compulsory enterprise questionnaire must be submitted

Telegraphic, telexed or faxed Request for Quotations will not be considered. The ECDoE does not bind itself to accepting the lowest Bidder. Request for quotation price offered should not pose a commercial risk to the completion of the project.

The ECDoE has the right to limit the number of Projects awarded to a single bidder.

The Quotations committee may or may not interview the bidder should it deem it necessary.

Procurement Contact Official

Mr Sinethemba Tonisi

Tel: 040 608 4280

Sinethemba.tonisi@ecdoe.gov.za

Infrastructure Contact Official

Mr Q Msiwa

Tel: 040 608 4707

Qigile.Msiwa@ecdoe.gov.za

PART A INVITATION TO BID

YOU ARE HEREBY INVITED TO BID FOR REQUIREMENTS OF THE (NAME OF DEPARTMENT/ PUBLIC ENTITY)					
BID NUMBER:	2022/07/065	CLOSING DATE:	28 September 2022	CLOSING TIME:	12h00
DESCRIPTION	PREFABRICATED STRUCTURE RELIEF PROGRAMME: SUPPLY AND ERECT TWO CLASSROOM BLOCK AT AMAZIZI SENIOR SECONDARY SCHOOL				
BID RESPONSE DOCUMENTS MAY BE DEPOSITED IN THE BID BOX SITUATED AT (STREET ADDRESS)					
RECEPTION AREA OF THE DEPARTMENT OF EDUCATION,					
STEVE VUKILE TSHWETE EDUCATION COMPLEX, ZONE 6,					
ZWELITSHA					
BIDDING PROCEDURE ENQUIRIES MAY BE DIRECTED TO			TECHNICAL ENQUIRIES MAY BE DIRECTED TO:		
CONTACT PERSON	S Tonisi		CONTACT PERSON	Mr Q Msiwa	
TELEPHONE NUMBER	040 608 4280		TELEPHONE NUMBER	040 608 4707	
FACSIMILE NUMBER			FACSIMILE NUMBER		
E-MAIL ADDRESS	Sinathemba.tonisi@ecdoe.gov.za		E-MAIL ADDRESS	qiqile.msiwa@edu.ecprov.gov.za	
SUPPLIER INFORMATION					
NAME OF BIDDER					
POSTAL ADDRESS					
STREET ADDRESS					
TELEPHONE NUMBER	CODE		NUMBER		
CELLPHONE NUMBER					
FACSIMILE NUMBER	CODE		NUMBER		
E-MAIL ADDRESS					
VAT REGISTRATION NUMBER					
SUPPLIER COMPLIANCE STATUS	TAX COMPLIANCE SYSTEM PIN:		OR	CENTRAL SUPPLIER DATABASE No:	MAAA
B-BBEE STATUS LEVEL VERIFICATION CERTIFICATE	TICK APPLICABLE BOX] <input type="checkbox"/> Yes <input type="checkbox"/> NO		B-BBEE STATUS LEVEL SWORN AFFIDAVIT	[TICK APPLICABLE BOX] <input type="checkbox"/> Yes <input type="checkbox"/> No	
[A B-BBEE STATUS LEVEL VERIFICATION CERTIFICATE/ SWORN AFFIDAVIT (FOR EMES & QSEs) MUST BE SUBMITTED IN ORDER TO QUALIFY FOR PREFERENCE POINTS FOR B-BBEE]					
ARE YOU THE ACCREDITED REPRESENTATIVE IN SOUTH AFRICA FOR THE GOODS /SERVICES /WORKS OFFERED?	<input type="checkbox"/> Yes <input type="checkbox"/> No [IF YES ENCLOSE PROOF]		ARE YOU A FOREIGN BASED SUPPLIER FOR THE GOODS /SERVICES /WORKS OFFERED?	<input type="checkbox"/> Yes <input type="checkbox"/> No [IF YES, ANSWER THE QUESTIONNAIRE BELOW]	
QUESTIONNAIRE TO BIDDING FOREIGN SUPPLIERS					

**PART B
TERMS AND CONDITIONS FOR BIDDING**

1. BID SUBMISSION:	
1.1.	BIDS MUST BE DELIVERED BY THE STIPULATED TIME TO THE CORRECT ADDRESS. LATE BIDS WILL NOT BE ACCEPTED FOR CONSIDERATION.
1.2.	ALL BIDS MUST BE SUBMITTED ON THE OFFICIAL FORMS PROVIDED-(NOT TO BE RE-TYPED) OR IN THE MANNER PRESCRIBED IN THE BID DOCUMENT.
1.3.	THIS BID IS SUBJECT TO THE PREFERENTIAL PROCUREMENT POLICY FRAMEWORK ACT, 2000 AND THE PREFERENTIAL PROCUREMENT REGULATIONS, 2017, THE GENERAL CONDITIONS OF CONTRACT (GCC) AND, IF APPLICABLE, ANY OTHER SPECIAL CONDITIONS OF CONTRACT.
1.4.	THE SUCCESSFUL BIDDER WILL BE REQUIRED TO FILL IN AND SIGN A WRITTEN CONTRACT FORM (SBD7).
2. TAX COMPLIANCE REQUIREMENTS	
2.1	BIDDERS MUST ENSURE COMPLIANCE WITH THEIR TAX OBLIGATIONS.
2.2	BIDDERS ARE REQUIRED TO SUBMIT THEIR UNIQUE PERSONAL IDENTIFICATION NUMBER (PIN) ISSUED BY SARS TO ENABLE THE ORGAN OF STATE TO VERIFY THE TAXPAYER'S PROFILE AND TAX STATUS.
2.3	APPLICATION FOR TAX COMPLIANCE STATUS (TCS) PIN MAY BE MADE VIA E-FILING THROUGH THE SARS WEBSITE WWW.SARS.GOV.ZA.
2.4	BIDDERS MAY ALSO SUBMIT A PRINTED TCS CERTIFICATE TOGETHER WITH THE BID.
2.5	IN BIDS WHERE CONSORTIA / JOINT VENTURES / SUB-CONTRACTORS ARE INVOLVED; EACH PARTY MUST SUBMIT A SEPARATE TCS CERTIFICATE / PIN / CSD NUMBER.
2.6	WHERE NO TCS PIN IS AVAILABLE BUT THE BIDDER IS REGISTERED ON THE CENTRAL SUPPLIER DATABASE (CSD), A CSD NUMBER MUST BE PROVIDED.
2.7	NO BIDS WILL BE CONSIDERED FROM PERSONS IN THE SERVICE OF THE STATE, COMPANIES WITH DIRECTORS WHO ARE PERSONS IN THE SERVICE OF THE STATE, OR CLOSE CORPORATIONS WITH MEMBERS PERSONS IN THE SERVICE OF THE STATE."

NB: FAILURE TO PROVIDE / OR COMPLY WITH ANY OF THE ABOVE PARTICULARS MAY RENDER THE BID INVALID.

SIGNATURE OF BIDDER:

CAPACITY UNDER WHICH THIS BID IS SIGNED:
(Proof of authority must be submitted e.g. company resolution)

DATE:

T1.2 Request for Quotation Data

T1.2: REQUEST FOR QUOTATION DATA

Project title:	PREFABRICATED STRUCTURE RELIEF PROGRAMME: SUPPLY AND ERECT TWO CLASSROOM BLOCK AT AMAZIZI SENIOR SECONDARY SCHOOL		
Request for Quotation No:	2022/07/065		
Advertising date:	14 September 2022	Closing date:	28 September 2022
Closing time:	12h00	Validity period	120 Days

Clause number																																	
	<p>The conditions of Request for Quotation applicable to this contract are the Standard Conditions of Tender as contained in Annexure C of the CIDB Standard for Uniformity in Construction Procurement (August 2019) as published in Government Gazette No. 42622, Department of Public Works Notice 423.</p> <p>The Standard Conditions of Bid make several references to the Bid Data for details that apply specifically to this Bid. The Bid Data shall have precedence in the interpretation of any ambiguity or inconsistency between it and the standard conditions of Bid.</p> <p>Each item of data given below is cross-referenced to the clause in the Standard Conditions of Bid to which it mainly applies.</p>																																
C.1.2	The employer is the Eastern Cape Province Department of Education																																
C.1.3.1	<p>The Request for Quotation documents issued by the employer comprise:</p> <p>THE REQUEST FOR QUOTATION (SINGLE VOLUME) Part 1: Bidding Procedure T1.1 Request for Quotation Notice and Invitation to Bid (SBD1) T1.2 Request for Quotation Data</p> <p>Part 2: Agreement and Contract Data C1.1 Form of Offer and Acceptance C1.1a Final Summary of Bills of Quantities (C2.2) C1.1b Standard Conditions of Tender C1.2 Contract Data C1.3 Form of Guarantee</p> <p>Part 3: Returnable Schedules/Documents T2.1 List of Returnable Documents T2.2 Returnable Documents:</p> <table border="1" style="width: 100%; border-collapse: collapse;"> <tr> <td style="width: 15%;">SBD4</td> <td style="width: 65%;">Declaration of interest</td> <td style="width: 20%;">Mandatory Requirement</td> </tr> <tr> <td>SBD6.1</td> <td>Preference points claim form in terms of Preferential Procurement Regulations 2017</td> <td>Mandatory Requirement</td> </tr> <tr> <td>SBD6.2</td> <td>Local production and content</td> <td>Mandatory Requirement</td> </tr> <tr> <td>T2.2.1</td> <td>Certificate of authority for signatory</td> <td>Mandatory Requirement</td> </tr> <tr> <td>T2.2.2</td> <td>Certificate of authority for joint ventures</td> <td>Mandatory Requirement</td> </tr> <tr> <td>T2.2.5</td> <td>Record of addenda to Request for Quotation documents</td> <td>Additional documents</td> </tr> <tr> <td>T2.2.6</td> <td>Capacity of Bidder</td> <td>Additional documents</td> </tr> <tr> <td>T2.2.7</td> <td>Relevant project experience - completed projects</td> <td>Additional documents</td> </tr> <tr> <td>T2.2.8</td> <td>Relevant project experience - current projects</td> <td>Additional documents</td> </tr> <tr> <td>T2.2.9</td> <td>Schedule of plant & equipment</td> <td>Additional documents</td> </tr> </table>			SBD4	Declaration of interest	Mandatory Requirement	SBD6.1	Preference points claim form in terms of Preferential Procurement Regulations 2017	Mandatory Requirement	SBD6.2	Local production and content	Mandatory Requirement	T2.2.1	Certificate of authority for signatory	Mandatory Requirement	T2.2.2	Certificate of authority for joint ventures	Mandatory Requirement	T2.2.5	Record of addenda to Request for Quotation documents	Additional documents	T2.2.6	Capacity of Bidder	Additional documents	T2.2.7	Relevant project experience - completed projects	Additional documents	T2.2.8	Relevant project experience - current projects	Additional documents	T2.2.9	Schedule of plant & equipment	Additional documents
SBD4	Declaration of interest	Mandatory Requirement																															
SBD6.1	Preference points claim form in terms of Preferential Procurement Regulations 2017	Mandatory Requirement																															
SBD6.2	Local production and content	Mandatory Requirement																															
T2.2.1	Certificate of authority for signatory	Mandatory Requirement																															
T2.2.2	Certificate of authority for joint ventures	Mandatory Requirement																															
T2.2.5	Record of addenda to Request for Quotation documents	Additional documents																															
T2.2.6	Capacity of Bidder	Additional documents																															
T2.2.7	Relevant project experience - completed projects	Additional documents																															
T2.2.8	Relevant project experience - current projects	Additional documents																															
T2.2.9	Schedule of plant & equipment	Additional documents																															

	T2.2.10	Compulsory enterprise questionnaire	Mandatory Requirement
	T2.2.11	CIDB grading certificate	Mandatory Requirement
	T2.2.12	Other certificates (certified copies to be inserted by Bidder), etc	Mandatory Requirement
		<ul style="list-style-type: none"> • Certified copy of CIPC company registration certificate • Certified copies of ID's of shareholders, members, partners or sole owner • Letter of Good Standing from Bank where Bidder's primary transaction account is • Certified copy of B-BBEE verification certificate or sworn affidavit; a consolidated B-BBEE verification certificate or sworn affidavit to be submitted in the case of a Joint Venture • Letter of Good Standing from Compensation Fund or a licensed insurer as contemplated in the Compensation for Occupational Injuries and Diseases Act 1993 • CSD Registration Summary Report dated not more than thirty (30) days prior to the Request for Quotation closing date. • Original valid SARS tax clearance certificate and pin 	Mandatory Requirement
	T2.2.13	Completed project reference forms	Additional documents
		<ul style="list-style-type: none"> • Priced BoQ 	Mandatory Requirement
	<p>THE CONTRACT</p> <p>Part 4: Scope of Work</p> <p>C3.1 Scope of work</p> <p>C3.2 Health and Safety Specification</p> <p>C3.4 Contractors Reports</p> <p>Part 5: Pricing data</p> <p>C2.1 Pricing instructions</p> <p>C2.2 Preliminaries / Bill of Quantities / Final Summary</p> <p>Part 6: Site information</p> <p>C4 Site information</p> <p>C5 Drawings</p>		
C.1.4	The employer's agent is:		
	Name:	Q Msiwa (Eastern Cape Province Department of Education)	
	Capacity:	Principal Agent	
	Address:	Steve Tshwete Building	
	Tel:	(040) 608 4707	
	Fax:		
	E-mail:	qiqile.msiwa@ecdoe.gov.za	
C.2.1	<p>Only those Bidders who satisfy the following eligibility criteria should submit Request for Quotations:</p> <ol style="list-style-type: none"> 1. Submit an offer only if the Bidder satisfies the criteria stated in the Request for Quotation data and the Bidder, or any of his principals, is not under any restriction to do business with the employer. 2. The Bidder is registered with the CIDB, in a 2GB or higher class of construction work. 		

	<p>3. The Bidder is registered on the National Treasury Central Supplier Data Base (https://secure.csd.gov.za)</p> <p>4. The Bidder accepts that documents that have correction fluid on them will be deemed non-responsive and the documents must remain intact.</p> <p>5. Bidders adhere to the pre-qualification criteria stated in the Request for Quotation document, if any.</p>
C.2.1	<p>Joint ventures are eligible to submit Bids provided that:</p> <ol style="list-style-type: none"> 1. Every member of the joint venture must be registered with the CIDB in the General Building (GB) class of work. 2. The combined contractor grading designation of the members calculated in accordance with the Construction Industry Development Regulations is equal to or higher than a contractor grading designation determined in accordance with the sum bid for a 2GB or Higher class of construction work. 3. The members/parties have signed a joint venture agreement. 4. A B-BBEE verification certificate or sworn affidavit in the name of the joint venture must be submitted in order to qualify for the preference points.
C.2.7	<p>The arrangements for the compulsory clarification meeting, if any, are as stated in the Request for Quotation Notice (T1.1).</p> <p>A Request for Quotation will not be considered if the Bidder or their representative has not attended the compulsory briefing session.</p> <p>Bidders must sign the attendance register in the name of the bidding entity.</p> <p>Addenda will be issued to and Request for Quotations will be received only from those bidding entities appearing on the attendance register.</p> <p>Request for Quotation documents will not be issued at the clarification meeting.</p>
C.2.8	<p>Request clarification at least 3 calendar days before the closing time.</p>
C2.11	<p>All documents must be completed and signed in black permanent ink. No correction fluid must be used in the document. Incomplete bid responses may be disqualified or evaluated solely on the information contained in the bid. The ECDoE may disregard any content in the Request for Quotation that is illegible and will be under no obligation whatsoever to seek clarification from the bidder.</p>
C.2.12	<p>If a Bidder wishes to submit an alternative Request for Quotation offer, the only criteria permitted for such alternative Request for Quotation offer is that it demonstrably satisfies the employer's standards and requirements, the details of which may be obtained from the Employer's Agent.</p> <p>Calculations, drawings and all other pertinent technical information and characteristics as well as modified or proposed Pricing Data must be submitted with the alternative Request for Quotation offer to enable the employer to evaluate the efficacy of the alternative and its principal elements, to take a view on the degree to which the alternative complies with the employer's standards and requirements and to evaluate the acceptability of the pricing proposals. Calculations must be set out in a clear and logical sequence and must clearly reflect all design assumptions. Pricing Data must reflect all assumptions in the development of the pricing proposal.</p> <p>Acceptance of an alternative Request for Quotation offer will mean acceptance in principle of the offer. It will be an obligation of the contract for the Bidder, in the event that the alternative is accepted, to accept full responsibility and liability that the alternative offer complies in all respects with the employer's standards and requirements.</p> <p>The modified Pricing Data must include an amount equal to 5% of the amount bid for the alternative offer to cover the employer's costs of confirming the acceptability of the detailed design before it is</p>

	constructed. Alternative Bid offer permitted: Yes <input type="checkbox"/> No <input checked="" type="checkbox"/>
C.2.13 C.2.15	The employer's address for delivery of Request for Quotation offers and identification details to be shown on each Request for Quotation offer package are as per Request for Quotation Notice (T1.1) and Invitation to Bid (SBD 1)
C.2.13.5	Request for Quotation offers shall be submitted as originals only.
C.2.13.6	A two-envelope system is not required.
C.2.13.9	Telephonic, telegraphic, telex, facsimile, emailed, electronic copy or late offers will not be accepted.
C.2.15	The closing time for submission of Request for Quotation offers is as per the Request for Quotation Notice (T1.1) and the Invitation to Bid (SBD 1).
C.2.16	The Request for Quotation offer validity period is as per the Request for Quotation Notice (T1.1) and the Invitation to Bid (SBD 1).
C.2.17	Provide clarification of the Request for Quotation offer in response to do so from the employer during the evaluation of Request for Quotation offers. This may include providing a breakdown of rates or prices and correction of arithmetical errors by the adjustment of certain rates or item prices (or both). No change in the competitive position of Bidders or substance of the Request for Quotation offer is sought, offered, or permitted.
C.2.22	Not a requirement
C.2.23	Refer to Parts 1, 2 & 3 for certificates and other documents to be submitted with the Request for Quotation.
C.3.4	The time and location for opening of the Request for Quotation offers are as per the Request for Quotation Notice (T1.1).
C.3.11	<p>Financial Offer and Preference will be evaluated as follows:</p> <p>The 80/20 preference point system will be applicable with 80 points allocated to Price and 20 points towards B-BBEE status level of contribution.</p> <p>The score for price is calculated using the following formula:</p> $P_s = 80 \left(1 - \frac{P_t - P_{\min}}{P_{\min}} \right)$ <p>Where:</p> <p>Ps = Points scored for price of bid under consideration;</p> <p>Pt = Price of bid under consideration and</p> <p>Pmin = Price of lowest acceptable bid.</p> <p>The following table will be used to calculate the score out of 20 (twenty) for preference based on the Bidder's B-BBEE status level of contribution:</p> <p>Level 1 - 20 points Level 2 - 18 points Level 3 - 14 points</p>

	<p>Level 4 - 12 points Level 5 - 8 points Level 6 - 6 points Level 7 - 4 points Level 8 - 2 point Non-compliant contributor - 0 points</p> <p>Preference points will only be awarded to those Bidders that have submitted a valid certified copy of the bidding entity's B-BBEE verification certificate verified by a SANAS approved rating agency or a sworn affidavit.</p> <p>A trust, consortium or joint venture will qualify for points for their B-BBEE status level as a legal entity, provided that the entity submits their B-BBEE verification certificate or a sworn affidavit.</p> <p>A trust, consortium or joint venture will qualify for points for their B-BBEE status level as an unincorporated entity, provided that the entity submits their consolidated B-BBEE scorecard or affidavit as if they were a group structure and that such a consolidated B-BBEE scorecard or affidavit is prepared for every separate Request for Quotation.</p>
C.3.11	
C.3.13	<p>Request for Quotation offers will only be accepted if:</p> <ol style="list-style-type: none"> 1. The Bidder or any of its directors/shareholders is not listed on the Register of Tender Defaulters in terms of the Prevention and Combating of Corrupt Activities Act of 2004 as a person prohibited from doing business with the public sector; 2. The Bidder has not: <ol style="list-style-type: none"> a. Abused the Employer's Supply Chain Management System; or b. Failed to perform on any previous contract and has been given a written notice to this effect; 3. The Bidder has completed the compulsory declarations and there are no conflicts of interest, which may impact on the Bidder's ability to perform the contract in the best interests of the employer or potentially compromise the Request for Quotation process; 4. The Bidder has registered on the Centralized Supplier Database (CSD) prior to submitting Request for Quotations (open Request for Quotations). Any prospective Bidder found to have tax matters not in order with SARS during the evaluation process will be eliminated and not be considered further; 5. The Bidder is registered with the Construction Industry Development Board in an appropriate contractor grading designation; <p>The Bidder is in good standing with the Compensation Fund.</p>
C.3.17	<p>The number of paper copies of the signed contract to be provided by the employer is 1 (one) copy of the signed contract to the successful Bidder.</p>

Part 2: AGREEMENT AND CONTRACT DATA

C1.1 Form of Offer and Acceptance

C1.1: FORM OF OFFER AND ACCEPTANCE

Project title:	PREFABRICATED STRUCTURE RELIEF PROGRAMME: SUPPLY AND ERECT TWO CLASSROOM BLOCK AT AMAZIZI SENIOR SECONDARY SCHOOL
Request for Quotation No:	2022/07/065

OFFER

The employer, identified in the acceptance signature block, has solicited offers to enter into a contract for the procurement of:

PREFABRICATED STRUCTURE RELIEF PROGRAMME: SUPPLY AND ERECT TWO CLASSROOM BLOCK AT AMAZIZI SENIOR SECONDARY SCHOOL

The Bidder, identified in the offer signature block, has examined the documents listed in the Request for Quotation data and addenda thereto as listed in the returnable schedules, and by submitting this offer has accepted the conditions of Request for Quotation.

By the representative of the Bidder, deemed to be duly authorized, signing this part of this form of offer and acceptance, the Bidder offers to perform all of the obligations and liabilities of the contractor under the contract including compliance with all its terms and conditions according to their true intent and meaning for an amount to be determined in accordance with the conditions of contract identified in the contract data.

THE OFFERED TOTAL OF THE PRICES INCLUSIVE OF VALUE ADDED TAX IS

.....

.....Rand (in words);

R(in figures)

This offer may be accepted by the employer by signing the acceptance part of this form of offer and acceptance and returning one copy of this document to the Bidder before the end of the period of validity stated in the Request for Quotation data, whereupon the Bidder becomes the party named as the contractor in the conditions of contract identified in the contract data.

Signature(s)

Name(s)

Capacity

for the Bidder

.....
(Name and address of organization)

Name and signature of witness Date

ACCEPTANCE

By signing this part of this form of offer and acceptance, the employer identified below accepts the Bidder's offer. In consideration thereof, the employer shall pay the contractor the amount due in accordance with the conditions of contract identified in the contract data. Acceptance of the Bidder's offer shall form an agreement between the employer and the Bidder upon the terms and conditions contained in this agreement and in the contract that is the subject of this agreement.

The terms of the contract, are contained in:

Part C1 Agreements and contract data, (which includes this agreement)

Part C2 Pricing data

Part C3 Scope of work.

Part C4 Site information and drawings and documents or parts thereof, which may be incorporated by reference into the above listed Parts.

Deviations from and amendments to the documents listed in the Request for Quotation data and any addenda thereto as listed in the returnable schedules as well as any changes to the terms of the offer agreed by the Bidder and the employer during this process of offer and acceptance, are contained in the schedule of deviations attached to and forming part of this form of offer and acceptance. No amendments to or deviations from said documents are valid unless contained in this schedule.

The Bidder shall within 2 (two) weeks after receiving a completed copy of this agreement, including the schedule of deviations (if any), contact the employer's agent (whose details are given in the contract data) to arrange the delivery of any securities, bonds, guarantees, proof of insurance and any other documentation to be provided in terms of the conditions of contract identified in the contract data. Failure to fulfil any of these obligations in accordance with those terms shall constitute a repudiation of this agreement.

Notwithstanding anything contained herein, this agreement comes into effect on the date when the Bidder receives one fully completed original copy of this document, including the schedule of deviations (if any). Unless the Bidder (now contractor) within 5 (five) working days of the date of such receipt notifies the employer in writing of any reason why he cannot accept the contents of this agreement, this agreement shall constitute a binding contract between the parties.

Signature(s)

Name(s)

Capacity

for the Employer

.....
(Name and address of organization)

Name and signature of witness Date

Schedule of Deviations

Notes:

- 1. *The extent of deviations from the Request for Quotation documents issued by the employer before the Request for Quotation closing date is limited to those permitted in terms of the conditions of Request for Quotation.*
- 2. *A Bidder's covering letter shall not be included in the final contract document. Should any matter in such letter, which constitutes a deviation as aforesaid, become the subject of agreements reached during the process of offer and acceptance, the outcome of such agreement shall be recorded here.*
- 3. *Any other matter arising from the process of offer and acceptance either as a confirmation, clarification or change to the Request for Quotation documents and which it is agreed by the Parties becomes an obligation of the contract shall also be recorded here.*
- 4. *Any change or addition to the Request for Quotation documents arising from the above agreements and recorded here, shall also be incorporated into the final draft of the Contract.*

1. Subject _____
Details _____

2. Subject _____
Details _____

3. Subject _____
Details _____

4. Subject _____
Details _____

By the duly authorised representatives signing this agreement, the employer and the Bidder agree to and accept the foregoing schedule of deviations as the only deviations from and amendments to the documents listed in the Request for Quotation data and addenda thereto as listed in the Request for Quotation schedules, as well as any confirmation, clarification or changes to the terms of the offer agreed by the Bidder and the employer during this process of offer and acceptance.

It is expressly agreed that no other matter whether in writing, oral communication or implied during the period between the issue of the Request for Quotation/ quotation documents and the receipt by the Bidder of a completed signed copy of this Agreement shall have any meaning or effect in the contract between the parties arising from this agreement.

C1.1a **Final Summary of Bills of Quantities**

**PREFABRICATED CLASSROOMS
DEPARTMENT OF EDUCATION EASTERN CAPE**

Bill No	<u>FINAL SUMMARY</u>	Page No		Amount
1	Alternative Building Technology	4		
2	External Work	8		
3	Provisional Sums	9		
	<u>CONTINGENCIES</u>			
	Allow the sum of R10,000.00 (Ten Thousand Rand) for Contingencies to be used or deducted in full at the Principal Agent's discretion.		R	10,000.00
	Sub Total		R	
	Add Value Added Tax at the rate of 15%		R	
	Carried to Form of Tender		R	

C1.1b Standard Conditions of Tender

CIDB Standard Conditions of Tender (August 2019 Edition)

(As contained in Annexure C of the CIDB Standard for Uniformity in Engineering and Construction Works Contracts in Board Notice 423 of 2019 in Government Gazette No 42622 of 8 August 2019)

C.1 General

C.1.1 Actions

C.1.1.1 The employer and each tenderer submitting a tender offer shall comply with these conditions of tender. In their dealings with each other, they shall discharge their duties and obligations as set out in C.2 and C.3, timeously and with integrity, and behave equitably, honestly and transparently, comply with all legal obligations and not engage in anticompetitive practices.

C.1.1.2 The employer and the tenderer and all their agents and employees involved in the tender process shall avoid conflicts of interest and where a conflict of interest is perceived or known, declare any such conflict of interest, indicating the nature of such conflict. Bidders shall declare any potential conflict of interest in their tender submissions. Employees, agents and advisors of the employer shall declare any conflict of interest to whoever is responsible for overseeing the procurement process at the start of any deliberations relating to the procurement process or as soon as they become aware of such conflict and abstain from any decisions where such conflict exists or recuse themselves from the procurement process, as appropriate.

Note: 1) A conflict of interest may arise due to a conflict of roles which might provide an incentive for improper acts in some circumstances. A conflict of interest can create an appearance of impropriety that can undermine confidence in the ability of that person to act properly in his or her position even if no improper acts result.

2) Conflicts of interest in respect of those engaged in the procurement process include direct, indirect or family interests in the tender or outcome of the procurement process and any personal bias, inclination, obligation, allegiance or loyalty which would in any way affect any decisions taken.

C.1.1.3 The employer shall not seek and a tenderer shall not submit a tender without having a firm intention and the capacity to proceed with the contract.

C.1.2 Tender Documents

The documents issued by the employer for the purpose of a tender offer are listed in the tender data.

C.1.3 Interpretation

C.1.3.1 The tender data and additional requirements contained in the tender schedules that are included in the returnable documents are deemed to be part of these conditions of tender.

C.1.3.2 These conditions of tender, the tender data and tender schedules which are required for tender evaluation purposes, shall form part of any contract arising from the invitation to tender.

C.1.3.3 For the purposes of these conditions of tender, the following definitions apply:

- a) **conflict of interest** means any situation in which:
 - i) someone in a position of trust has competing professional or personal interests which make it difficult to fulfill his or her duties impartially;
 - ii) an individual or tenderer is in a position to exploit a professional or official capacity in some way for their personal or corporate benefit; or
 - iii) incompatibility or contradictory interests exist between an employee and the tenderer who employs that employee.
- b) **comparative offer** means the price after the factors of a non-firm price and all unconditional discounts it can be utilised to have been taken into consideration;
- c) **corrupt practice** means the offering, giving, receiving or soliciting of anything of value to influence the action of the employer or his staff or agents in the tender process;
- d) **fraudulent practice** means the misrepresentation of the facts in order to influence the tender process or the award of a contract arising from a tender offer to the detriment of the employer, including collusive practices intended to establish prices at artificial levels;

C.1.4 Communication and employer's agent

Each communication between the employer and a tenderer shall be to or from the employer's agent only, and in a form that can be readily read, copied and recorded. Communications shall be in the English language. The employer shall not take any responsibility for non-receipt of communications from or by a tenderer. The name and contact details of the employer's agent are stated in the tender data.

C.1.5 Cancellation and Re-Invitation of Tenders

C.1.5.1 An employer may, prior to the award of the tender, cancel a tender if:

- a) due to changed circumstances, there is no longer a need for the engineering and construction works specified in the invitation;
- b) funds are no longer available to cover the total envisaged expenditure; or
- c) no acceptable tenders are received.
- d) there is a material irregularity in the tender process.

C.1.5.2 The decision to cancel a tender invitation must be published in the same manner in which the original tender invitation was advertised

C.1.5.3 An employer may only with the prior approval of the relevant treasury cancel a tender invitation for the second time.

C.1.6 Procurement procedures

C.1.6.1 General

Unless otherwise stated in the tender data, a contract will, subject to C.3.13, be concluded with the tenderer who in terms of C.3.11 is the highest ranked or the tenderer scoring the highest number of tender evaluation points, as relevant, based on the tender submissions that are received at the closing time for tenders.

C.1.6.2 Competitive negotiation procedure

C.1.6.2.1 Where the tender data require that the competitive negotiation procedure is to be followed, Bidders shall submit tender offers in response to the proposed contract in the first round of submissions.

Notwithstanding the requirements of C.3.4, the employer shall announce only the names of the Bidders who make a submission. The requirements of C.8 relating to the material deviations or qualifications which affect the competitive position of Bidders shall not apply.

C.1.6.2.2 All responsive Bidders or at least a minimum of not less than three responsive Bidders that are highest ranked in terms of the evaluation criteria stated in the tender data shall be invited to enter into competitive negotiations based on the principle of equal treatment, keeping confidential the proposed solutions and associated information. Notwithstanding the provisions of C.2.17, the employer may request that tenders be clarified, specified and fine-tuned in order to improve a tenderer's competitive position provided that such clarification, specification, fine-tuning or additional information does not alter any fundamental aspects of the offers or impose substantial new requirements which restrict or distort competition or have a discriminatory effect.

C.1.6.2.3 At the conclusion of each round of negotiations, Bidders shall be invited by the employer to revise their tender offer based on the same evaluation criteria, with or without adjusted weightings. Bidders shall be advised when they are to submit their best and final offer.

C.1.6.2.4 The contract shall be awarded in accordance with the provisions of C.3.11 and C.3.13 after Bidders have been requested to submit their best and final offer.

C.1.6.3 Proposal procedure using the two stage-system

C.1.6.3.1 Option 1

Bidders shall in the first stage submit technical proposals and, if required, cost parameters around which a contract may be negotiated. The employer shall evaluate each responsive submission in terms of the method of evaluation stated in the tender data, and in the second stage negotiate a contract with the tenderer scoring the highest number of evaluation points and award the contract in terms of these

conditions of tender.

C.1.6.3.2 Option 2

C.1.6.3.2.1 Bidders shall submit in the first stage only technical proposals. The employer shall invite all responsive Bidders to submit tender offers in the second stage, following the issuing of procurement documents.

C.1.6.3.2.2 The employer shall evaluate tenders received during the second stage in terms of the method of evaluation stated in the tender data, and award the contract in terms of these conditions of tender.

C.2 Tenderer's obligations

C.2.1 Eligibility

C.2.1.1 Submit a tender offer only if the tenderer satisfies the criteria stated in the tender data and the tenderer, or any of his principals, is not under any restriction to do business with employer.

C.2.1.2 Notify the employer of any proposed material change in the capabilities or formation of the tendering entity (or both) or any other criteria which formed part of the qualifying requirements used by the employer as the basis in a prior process to invite the tenderer to submit a tender offer and obtain the employer's written approval to do so prior to the closing time for tenders.

C.2.2 Cost of tendering

C.2.2.1 Accept that, unless otherwise stated in the tender data, the employer will not compensate the tenderer for any costs incurred in the preparation and submission of a tender offer, including the costs of any testing necessary to demonstrate that aspects of the offer complies with requirements.

C.2.2.2 The cost of the tender documents charged by the employer shall be limited to the actual cost incurred by the employer for printing the documents. Employers must attempt to make available the tender documents on its website so as not to incur any costs pertaining to the printing of the tender documents.

C.2.3 Check documents

Check the tender documents on receipt for completeness and notify the employer of any discrepancy or omission.

C.2.4 Confidentiality and copyright of documents

Treat as confidential all matters arising in connection with the tender. Use and copy the documents issued by the employer only for the purpose of preparing and submitting a tender offer in response to the invitation.

C.2.5 Reference documents

Obtain, as necessary for submitting a tender offer, copies of the latest versions of standards, specifications, conditions of contract and other publications, which are not attached but which are incorporated into the tender documents by reference.

C.2.6 Acknowledge addenda

Acknowledge receipt of addenda to the tender documents, which the employer may issue, and if necessary apply for an extension to the closing time stated in the tender data, in order to take the addenda into account.

C.2.7 Clarification meeting

Attend, where required, a clarification meeting at which Bidders may familiarize themselves with aspects of the proposed work, services or supply and raise questions. Details of the meeting(s) are stated in the tender data.

C.2.8 Seek clarification

Request clarification of the tender documents, if necessary, by notifying the employer at least five (5) working days before the closing time stated in the tender data.

C.2.9 Insurance

Be aware that the extent of insurance to be provided by the employer (if any) might not be for the full cover required in terms of the conditions of contract identified in the contract data. The tenderer is advised to seek qualified advice regarding insurance.

C.2.10 Pricing the tender offer

C.2.10.1 Include in the rates, prices, and the tendered total of the prices (if any) all duties, taxes except Value Added Tax (VAT), and other levies payable by the successful tenderer, such duties, taxes and levies being those applicable fourteen (14) days before the closing time stated in the tender data.

C.2.10.2 Show VAT payable by the employer separately as an addition to the tendered total of the prices.

C.2.10.3 Provide rates and prices that are fixed for the duration of the contract and not subject to adjustment except as provided for in the conditions of contract identified in the contract data.

C.2.10.4 State the rates and prices in Rand unless instructed otherwise in the tender data. The conditions of contract identified in the contract data may provide for part payment in other currencies.

C.2.11 Alterations to documents

Do not make any alterations or additions to the tender documents, except to comply with instructions issued by the employer, or necessary to correct errors made by the tenderer. All signatories to the tender offer shall initial all such alterations.

C.2.12 Alternative tender offers

C.2.12.1 Unless otherwise stated in the tender data, submit alternative tender offers only if a main tender offer, strictly in accordance with all the requirements of the tender documents, is also submitted as well as a schedule that compares the requirements of the tender documents with the alternative requirements that are proposed.

C.2.12.2 Accept that an alternative tender offer must be based only on the criteria stated in the tender data or criteria otherwise acceptable to the employer.

C.2.12.3 An alternative tender offer must only be considered if the main tender offer is the winning tender.

C.2.13 Submitting a tender offer

C.2.13.1 Submit one tender offer only, either as a single tendering entity or as a member in a joint venture to provide the whole of the works identified in the contract data and described in the scope of works, unless stated otherwise in the tender data.

C.2.13.2 Return all returnable documents to the employer after completing them in their entirety, either electronically (if they were issued in electronic format) or by writing legibly in non-erasable ink.

C.2.13.3 Submit the parts of the tender offer communicated on paper as an original plus the number of copies stated in the tender data, with an English translation of any documentation in a language other than English, and the parts communicated electronically in the same format as they were issued by the employer.

C.2.13.4 Sign the original and all copies of the tender offer where required in terms of the tender data. The employer will hold all authorized signatories liable on behalf of the tenderer. Signatories for Bidders proposing to contract as joint ventures shall state which of the signatories is the lead partner whom the employer shall hold liable for the purpose of the tender offer.

- C.2.13.5 Seal the original and each copy of the tender offer as separate packages marking the packages as "ORIGINAL" and "COPY". Each package shall state on the outside the employer's address and identification details stated in the tender data, as well as the tenderer's name and contact address.
- C.2.13.6 Where a two-envelope system is required in terms of the tender data, place and seal the returnable documents listed in the tender data in an envelope marked "financial proposal" and place the remaining returnable documents in an envelope marked "technical proposal". Each envelope shall state on the outside the employer's address and identification details stated in the tender data, as well as the tenderer's name and contact address.
- C.2.13.7 Seal the original tender offer and copy packages together in an outer package that states on the outside only the employer's address and identification details as stated in the tender data.
- C.2.13.8 Accept that the employer will not assume any responsibility for the misplacement or premature opening of the tender offer if the outer package is not sealed and marked as stated.
- C.2.13.9 Accept that tender offers submitted by facsimile or e-mail will be rejected by the employer, unless stated otherwise in the tender data.

C.2.14 Information and data to be completed in all respects

Accept that tender offers, which do not provide all the data or information requested completely and in the form required, may be regarded by the employer as non-responsive.

C.2.15 Closing time

- C.2.15.1 Ensure that the employer receives the tender offer at the address specified in the tender data not later than the closing time stated in the tender data. Accept that proof of posting shall not be accepted as proof of delivery.
- C.2.15.2 Accept that, if the employer extends the closing time stated in the tender data for any reason, the requirements of these conditions of tender apply equally to the extended deadline.

C.2.16 Tender offer validity

- C.2.16.1 Hold the tender offer(s) valid for acceptance by the employer at any time during the validity period stated in the tender data after the closing time stated in the tender data.
- C.2.16.2 If requested by the employer, consider extending the validity period stated in the tender data for an agreed additional period with or without any conditions attached to such extension.
- C.2.16.3 Accept that a tender submission that has been submitted to the employer may only be withdrawn or substituted by giving the employer's agent written notice before the closing time for tenders that a tender is to be withdrawn or substituted. If the validity period stated in C.2.16 lapses before the employer evaluating tender, the contractor reserves the right to review the price based on Consumer Price Index (CPI).
- C.2.16.4 Where a tender submission is to be substituted, a tenderer must submit a substitute tender in accordance with the requirements of C.2.13 with the packages clearly marked as "SUBSTITUTE".

C.2.17 Clarification of tender offer after submission

Provide clarification of a tender offer in response to a request to do so from the employer during the evaluation of tender offers. This may include providing a breakdown of rates or prices and correction of arithmetical errors by the adjustment of certain rates or item prices (or both). No change in the competitive position of Bidders or substance of the tender offer is sought, offered, or permitted.

Note: Sub-clause C.2.17 does not preclude the negotiation of the final terms of the contract with a preferred tenderer following a competitive selection process, should the Employer elect to do so.

C.2.18 Provide other material

C.2.18.1 Provide, on request by the employer, any other material that has a bearing on the tender offer, the tenderer's commercial position (including notarized joint venture agreements), preferencing arrangements, or samples of materials, considered necessary by the employer for the purpose of a full and fair risk assessment. Should the tenderer not provide the material, or a satisfactory reason as to why it cannot be provided, by the time for submission stated in the employer's request, the employer may regard the tender offer as non-responsive.

C.2.18.2 Dispose of samples of materials provided for evaluation by the employer, where required.

C.2.19 Inspections, tests and analysis

Provide access during working hours to premises for inspections, tests and analysis as provided for in the tender data.

C.2.20 Submit securities, bonds and policies

If requested, submit for the employer's acceptance before formation of the contract, all securities, bonds, guarantees, policies and certificates of insurance required in terms of the conditions of contract identified in the contract data.

C.2.21 Check final draft

Check the final draft of the contract provided by the employer within the time available for the employer to issue the contract.

C.2.22 Return of other tender documents

If so instructed by the employer, return all retained tender documents within twenty-eight (28) days after the expiry of the validity period stated in the tender data.

C.2.23 Certificates

Include in the tender submission or provide the employer with any certificates as stated in the tender data.

C.3 The employer's undertakings

C.3.1 Respond to requests from the tenderer

C.3.1.1 Unless otherwise stated in the tender Data, respond to a request for clarification received up to five (5) working days before the tender closing time stated in the Tender Data and notify all Bidders who collected tender documents.

C.3.1.2 Consider any request to make a material change in the capabilities or formation of the tendering entity (or both) or any other criteria which formed part of the qualifying requirements used to prequalify a tenderer to submit a tender offer in terms of a previous procurement process and deny any such request if as a consequence:

- a) an individual firm, or a joint venture as a whole, or any individual member of the joint venture fails to meet any of the collective or individual qualifying requirements;
- b) the new partners to a joint venture were not prequalified in the first instance, either as individual firms or as another joint venture; or
- c) in the opinion of the Employer, acceptance of the material change would compromise the outcome of the prequalification process.

C.3.2 Issue Addenda

If necessary, issue addenda that may amend or amplify the tender documents to each tenderer during the period from the date that tender documents are available until three (3) working days before the

tender closing time stated in the Tender Data. If, as a result a tenderer applies for an extension to the closing time stated in the Tender Data, the Employer may grant such extension and, shall then notify all Bidders who collected tender documents.

C.3.3 Return late tender offers

Return tender offers received after the closing time stated in the Tender Data, unopened, (unless it is necessary to open a tender submission to obtain a forwarding address), to the tenderer concerned.

C.3.4 Opening of tender submissions

C.3.4.1 Unless the two-envelope system is to be followed, open valid tender submissions in the presence of Bidders' agents who choose to attend at the time and place stated in the tender data. Tender submissions for which acceptable reasons for withdrawal have been submitted will not be opened.

C.3.4.2 Announce at the meeting held immediately after the opening of tender submissions, at a venue indicated in the tender data, the name of each tenderer whose tender offer is opened and, where applicable, the total of his prices, number of points claimed for its BBBEE status level and time for completion for the main tender offer only.

C.3.4.3 Make available the record outlined in C.3.4.2 to all interested persons upon request.

C.3.5 Two-envelope system

C.3.5.1 Where stated in the tender data that a two-envelope system is to be followed, open only the technical proposal of valid tenders in the presence of Bidders' agents who choose to attend at the time and place stated in the tender data and announce the name of each tenderer whose technical proposal is opened.

C.3.5.2 Evaluate functionality of the technical proposals offered by Bidders, then advise Bidders who remain in contention for the award of the contract of the time and place when the financial proposals will be opened. Open only the financial proposals of Bidders, who score in the functionality evaluation more than the minimum number of points for functionality stated in the tender data, and announce the score obtained for the technical proposals and the total price and any points claimed on BBBEE status level. Return unopened financial proposals to Bidders whose technical proposals failed to achieve the minimum number of points for functionality.

C.3.6 Non-disclosure

Not disclose to Bidders, or to any other person not officially concerned with such processes, information relating to the evaluation and comparison of tender offers, the final evaluation price and recommendations for the award of a contract, until after the award of the contract to the successful tenderer.

C.3.7 Grounds for rejection and disqualification

Determine whether there has been any effort by a tenderer to influence the processing of tender offers and instantly disqualify a tenderer (and his tender offer) if it is established that he engaged in corrupt or fraudulent practices.

C.3.8 Test for responsiveness

C.3.8.1 Determine, after opening and before detailed evaluation, whether each tender offer properly received:

- a) complies with the requirements of these Conditions of Tender,
- b) has been properly and fully completed and signed, and
- c) is responsive to the other requirements of the tender documents.

C.3.8.2 A responsive tender is one that conforms to all the terms, conditions, and specifications of the tender documents without material deviation or qualification. A material deviation or qualification is one which, in the Employer's opinion, would:

- a) detrimentally affect the scope, quality, or performance of the works, services or supply identified in the Scope of Work,

- b) significantly change the Employer's or the tenderer's risks and responsibilities under the contract, or
- c) affect the competitive position of other Bidders presenting responsive tenders, if it were to be rectified.

Reject a non-responsive tender offer, and not allow it to be subsequently made responsive by correction or withdrawal of the non-conforming deviation or reservation.

C.3.9 Arithmetical errors, omissions and discrepancies

C.3.9.1 Check responsive tenders for discrepancies between amounts in words and amounts in figures. Where there is a discrepancy between the amounts in figures and the amount in words, the amount in words shall govern.

C.3.9.2 Check the highest ranked tender or tenderer with the highest number of tender evaluation points after the evaluation of tender offers in accordance with C.3.11 for:

- a) the gross misplacement of the decimal point in any unit rate;
- b) omissions made in completing the pricing schedule or bills of quantities; or
- c) arithmetic errors in:
 - (i) line item totals resulting from the product of a unit rate and a quantity in bills of quantities or schedules of prices; or
 - (ii) the summation of the prices.

C.3.9.3 Notify the tenderer of all errors or omissions that are identified in the tender offer and either confirm the tender offer as tendered or accept the corrected total of prices.

C.3.9.4 Where the tenderer elects to confirm the tender offer as tendered, correct the errors as follows:

- a) If bills of quantities or pricing schedules apply and there is an error in the line item total resulting from the product of the unit rate and the quantity, the line item total shall govern and the rate shall be corrected. Where there is an obviously gross misplacement of the decimal point in the unit rate, the line item total as quoted shall govern, and the unit rate shall be corrected.
- b) Where there is an error in the total of the prices either as a result of other corrections required by this checking process or in the tenderer's addition of prices, the total of the prices shall govern and the tenderer will be asked to revise selected item prices (and their rates if bills of quantities apply) to achieve the tendered total of the prices.

C.3.10 Clarification of a tender offer

Obtain clarification from a tenderer on any matter that could give rise to ambiguity in a contract arising from the tender offer.

C.3.11 Evaluation of tender offers

The Standard Conditions of Tender standardize the procurement processes, methods and procedures from the time that tenders are invited to the time that a contract is awarded. They are generic in nature and are made project specific through choices that are made in developing the Tender Data associated with a specific project.

Conditions of tender are by definition the document that establishes a tenderer's obligations in submitting a tender and the employer's undertakings in soliciting and evaluating tender offers. Such conditions establish the rules from the time a tender is advertised to the time that a contract is awarded and require employers to conduct the process of offer and acceptance in terms of a set of standard procedures.

The CIDB Standard Conditions of Tender are based on a procurement system that satisfies the following system requirements:	
Requirement	Qualitative interpretation of goal
Fair	The process of offer and acceptance is conducted impartially without bias, providing simultaneous and timely access to participating parties to the same information.
Equitable	Terms and conditions for performing the work do not unfairly prejudice the interests of the parties.
Transparent	The only grounds for not awarding a contract to a tenderer who satisfies all requirements are restrictions from doing business with the employer, lack of capability or capacity, legal impediments and conflicts of interest.
Competitive	The system provides for appropriate levels of competition to ensure cost effective and best value

	outcomes.
Cost effective	The processes, procedures and methods are standardized with sufficient flexibility to attain best value outcomes in respect of quality, timing and price, and least resources to effectively manage and control procurement processes.

The activities associated with evaluating tender offers are as follows:

- a) Open and record tender offers received
- b) Determine whether or not tender offers are complete
- c) Determine whether or not tender offers are responsive
- d) Evaluate tender offers
- e) Determine if there are any grounds for disqualification
- f) Determine acceptability of preferred tenderer
- g) Prepare a tender evaluation report
- h) Confirm the recommendation contained in the tender evaluation report

C.3.11.1 General

The employer must appoint an evaluation panel of not less than three persons conversant with the proposed scope of works to evaluate each responsive tender offer using the tender evaluation methods and associated evaluation criteria and weightings that are specified in the tender data.

C.3.12 Insurance provided by the employer

If requested by the proposed successful tenderer, submit for the tenderer's information the policies and / or certificates of insurance which the conditions of contract identified in the contract data, require the employer to provide.

C.3.13 Acceptance of tender offer

Accept the tender offer; if in the opinion of the employer, it does not present any risk and only if the tenderer:

- a) is not under restrictions, or has principals who are under restrictions, preventing participating in the employer's procurement;
- b) can, as necessary and in relation to the proposed contract, demonstrate that he or she possesses the professional and technical qualifications, professional and technical competence, financial resources, equipment and other physical facilities, managerial capability, reliability, experience and reputation, expertise and the personnel, to perform the contract;
- c) has the legal capacity to enter into the contract;
- d) is not; insolvent, in receivership, under Business Rescue as provided for in chapter 6 of the Companies Act No. 2008, bankrupt or being wound up, has his/her affairs administered by a court or a judicial officer, has suspended his/her business activities or is subject to legal proceedings in respect of any of the foregoing;
- e) complies with the legal requirements, if any, stated in the tender data; and
- f) is able, in the opinion of the employer, to perform the contract free of conflicts of interest.

C.3.14 Prepare contract documents

C.3.14.1 If necessary, revise documents that shall form part of the contract and that were issued by the employer as part of the tender documents to take account of:

- a) addenda issued during the tender period,
- b) inclusion of some of the returnable documents and
- c) other revisions agreed between the employer and the successful tenderer.

C.3.14.2 Complete the schedule of deviations attached to the form of offer and acceptance, if any.

C.3.15 Complete adjudicator's contract

Unless alternative arrangements have been agreed or otherwise provided for in the contract, arrange for both parties to complete formalities for appointing the selected adjudicator at the same time as the main contract is signed.

C.3.16 Registration of the award

An employer must, within twenty-one (21) working days from the date on which a contractor's offer to perform a construction works contract is accepted in writing by the employer, register and publish the award on the cidb Register of Projects.

C.3.17 Provide copies of the contracts

Provide to the successful tenderer the number of copies stated in the Tender Data of the signed copy of the contract as soon as possible after completion and signing of the form of offer and acceptance.

C.3.18 Provide written reasons for actions taken

Provide upon request written reasons to Bidders for any action that is taken in applying these conditions of tender but withhold information which is not in the public interest to be divulged, which is considered to prejudice the legitimate commercial interests of Bidders or might prejudice fair competition between Bidders.

---oo0oo---

C1.2 Contract Data

**C1.2 : CONTRACT DATA : JBCC 2000 PRINCIPAL BUILDING AGREEMENT
(Edition 4.1 of March 2005)**

Project title:	PREFABRICATED STRUCTURE RELIEF PROGRAMME: SUPPLY AND ERECT TWO CLASSROOM BLOCK AT AMAZIZI SENIOR SECONDARY SCHOOL
Request for Quotation No:	2022/07/065

	<p>The Conditions of Contract are clauses 1 to 42 of the JBCC series 2000 Principal Building Agreement (Edition 4.1 of March 2005) prepared by the Joint Building Contracts Committee.</p> <p>Copies of these conditions of contract may be obtained from the Association of South African Quantity Surveyors, Master Builders Association, South African Association of Consulting Engineers, South African Institute of Architects, Association of Construction Project Managers, Building Industries Federation South Africa, South African Property Owners Association or Specialist Engineering Contractors Committee.</p>
--	---

	<p>CONTRACT VARIABLES</p> <p>THE SCHEDULE</p> <p>The schedule contains all the variables referred to in this document and is divided into part 1: contract data completed by the employer and part 2: contract data completed by the contractor. Part 1 must be completed in full and included in the Bidder documents. Both part 1 and part 2 form part of this agreement.</p> <p>Spaces requiring information must be filled in, shown as “not applicable” or deleted but not left blank. Where choices are offered, the non-applicable items are to be deleted. Where insufficient space is provided the information should be annexed hereto and cross referenced to the applicable clause of the schedule. Key cross reference clauses are italicised in [] brackets.</p>
--	---

42.0	PART 1: CONTRACT DATA PROVIDED BY THE EMPLOYER
-------------	---

42.1	CONTRACTING AND OTHER PARTIES
42.1.1	<p>Employer: Eastern Cape Province Department of Education</p> <p>Postal address: Private Bag X0032 BHISHO 5605</p> <p>Tel: 040 608 4335 Fax: 040 – 602 7272</p> <p>Physical address: Steve Tshwete Building Zone 6 Zwelitsha</p>
[1.2]	

42.1.2 [1.1, 5.1]	Principal Agent: Eastern Cape Province Department of Education Agent's service: Principal Agent Postal address: Private Bag X0032 BHISHO 5605 Tel: 040 608 4335 Fax: 040 – 602 7272
42.1.3 [1.1, 5.2]	Agent (1) - TBC Agent's service: Postal address: Tel: Fax:
42.1.4 [1.1, 5.2]	Agent (2) - TBC Agent's service: Postal address: Tel: Fax:
42.1.5 [1.1, 5.2]	Agent (3) - TBC Agent's service: Postal address: Tel: Fax:
42.1.6 [1.1, 5.2]	Agent (4) - TBC Agent's service: Postal address: Tel: Fax:
42.2	CONTRACT DETAILS
42.2.1 [1.1]	Works description: Refer to document C3.1 – Scope of Work.
42.2.2 [1.1]	Site description: Refer to document C4 – Site Information.
42.2.4 [41.0]	Specific options that are applicable to a State organ only Where so :
[31.1 #] [31.11.2 #] [31.12.2#]	1) Interest rate legislation: (a) in respect of interest owed by the employer , the interest rate as determined by the Minister of Justice and Constitutional Development from time to time, in terms of section 1(2) of the Prescribed Rate of Interest Act, 1975 (Act No. 55 of 1975), will apply; and

	(b) in respect of interest owed to the employer , the interest rate as determined by the Minister of Finance, from time to time, in terms of section 80(1)(b) of the Public Finance Management Act, 1999 (Act No. 1 of 1999), will apply
[11.2.#]	2) Lateral support insurance to be effected by the contractor : Yes <input type="checkbox"/> No <input checked="" type="checkbox"/>
[31.4.2 #]	3) Payment will be made for materials and goods on site: Yes <input checked="" type="checkbox"/> No <input type="checkbox"/> Under no circumstance will deposits due by the contractor to any supplier or subcontractor for materials or equipment be paid prior to the delivery to site thereof, after which it will be regarded as materials and goods on site.
[40.2.2.#]	4) Dispute resolution by adjudication: Yes <input checked="" type="checkbox"/> No <input type="checkbox"/>
[26.1.2 #]	5) Extended defects liability period is applicable to the following elements: - all civil works such as roads, parking areas, stormwater & soil drainage - all work done under electrical subcontracts - all work done under mechanical subcontracts
42.2.6 [15.3]	Period for the commencement of the works after the contractor takes possession of the site : Five (5) working days.
42.2.7 [24.3.1] [30.1]	For the works as a whole: The date for practical completion shall be Three (3) Months (including statutory holidays, but excluding the annual builders' shutdown period) from the date that possession of the site is given to the contractor and the penalty per calendar day shall be 16.5c per R100 of the contract value .
42.2.9 [1.2]	The law applicable to this agreement shall be that of the: Republic of South Africa
42.3	INSURANCES
42.3.1 [10.1 #, 10.2 #, 12.1 #]	Contract works insurance to be effected by the contractor <input checked="" type="checkbox"/> To the minimum value of the contract sum plus 20% With a deductible not exceeding 5% of each and every claim
42.3.2 [10.1#, 10.2 #, 12.1 #]	Supplementary insurance is required: Yes To the minimum value of the contract sum plus 20 %
42.3.3 [11.1#, 12.1 #]	Public liability insurance to be effected by the contractor <input checked="" type="checkbox"/> For the sum of R 5 million With a deductible not exceeding 5% of each and every claim
42.3.4 [11.2 #, 12.1 #]	Support insurance to be effected by the contractor : Not Applicable
42.4	DOCUMENTS
42.4.2 [3.7]	Three (3) copies of the construction documents will be supplied to the contractor free of charge
42.4.3	Bills of quantities / Lump sum document schedule of rates drawn up in accordance with: Standard System of Measuring Building Work (seventh edition as amended)

42.4.4 [15.1.1]	The priced bills of quantities shall be submitted with the Request for Quotation submission : Yes <input checked="" type="checkbox"/> No <input type="checkbox"/>
42.4.5 [3.4]	JBCC Engineering General Conditions are to be included in the contract documents : No

42.4.6 [31.5.3] [32.13]	<p>The contract value is to be adjusted using CPAP indices: Yes <input type="checkbox"/> No <input checked="" type="checkbox"/></p> <p>Where CPAP is applicable, the contract sum will be adjusted in accordance with the JBCC Contract Price Adjustment Provisions (CPAP) as set out in the CPAP Indices Application Manual as prepared by the JBCC Series 2000, code 2118, dated May 2005 and any amendments thereto:</p> <ol style="list-style-type: none"> 1) Glass etc. measured in specialist section Metalwork, will be adjusted in terms of the index for that work group unless specifically stated otherwise in the bills of quantities 2) All electrical installations in buildings and power distribution systems shall be adjusted in terms of the index for Work Group 160 Electrical Installation. In case of uninterruptible power supplies, elevators, escalators and hoists, generating sets, motor-alternator sets and intercommunication systems shall be in accordance with Work Group 170 3) With reference to Work Group 190 a proportion of the value related preliminaries pro rata to the amount of work excluded from adjustment, shall be excluded from Contract Price Adjustment Provisions, if Option A has been selected for the adjustment of preliminaries 4) Further to clause 3.4.4 of the CPAP Indices Application Manual, the listing of additional items for exclusion by Bidders, will not be permitted 5) Where V results in a negative amount after application of the formula in clause 8.3 of the CPAP Indices Application Manual the factor of 0,55 shall be substituted by 1,45 <p>Alternative Indices: Not Applicable</p>
-----------------------------------	--

42.4.7 [3.10]	<p>Details of changes made to the provisions of JBCC standard documentation</p> <p>Clause 1.1</p> <p>COMMENCEMENT DATE – means the date that the agreement, made in terms of the Offer and Acceptance, comes into effect.</p> <p>CONSTRUCTION GUARANTEE – means a guarantee at call obtained by the contractor from an institution approved by the employer in terms of the employer’s construction guarantee form as selected in the schedule.</p> <p>CONSTRUCTION PERIOD – means the period commencing on the date that possession of the site is given to the contractor and ending on the date of practical completion.</p> <p>CORRUPT PRACTICE – means the offering, giving, receiving or soliciting of anything of value to influence the action of a public official in the procurement process or in contract execution.</p> <p>FRAUDULENT PRACTICE – means a misrepresentation of facts in order to influence a procurement process or the execution of a contract to the detriment of any Bidder, and includes collusive practice among Bidders (prior to and after the Bidder submission) designed to establish Bidder prices at artificial non-competitive levels and to deprive the Bidder of the benefits of free and open competition.</p> <p>INTEREST – the interest rates applicable on this contract, whether specifically indicated in the relevant clauses or not, will be in terms of the legislation of the Republic of South Africa, and in particular: (a) in respect of interest owed by the employer, the interest rate as determined by the Minister of Justice and Constitutional Development from time to time, in terms of section 1(2) of the Prescribed Rate of Interest Act, 1975 (Act No. 55 of 1975), will apply; and</p>
------------------	--

(b) in respect of interest owed to the **employer**, the interest rate as determined by the Minister of Finance, from time to time, in terms of section 80(1)(b) of the Public Finance Management Act, 1999 (Act No. 1 of 1999), will apply

SECURITY – means the form of **security** provided by the **employer** or **contractor**, as stated in the **schedule**, from which the **contractor** or **employer** may recover expenses or loss.

1.6 Any notice given may be delivered by hand, sent by prepaid registered post or telefax. Notice shall be presumed to have been given when:

1.6.4 No clause

3.2.1 A **construction guarantee** in terms of 14.0, where so elected in his Bid.

3.7 Add at the end thereof:

The **contractor** shall supply and keep a copy of the **JBCC** Series 2000 Principal Building Agreement and Preliminaries applicable to this contract on the **site**, to which the **employer**, **principal agent** and **agents** shall have access to at all times.

3.10 Replace the second reference to “**principal agent**” with the word “**employer**”

4.3 No clause

5.1.2 under clause 41- Include reference to 32.6.3; 34.3 and 34.4 in terms of which the employer has retained its authority and has not given a mandate to the **principal agent** and in terms of which the employer shall sign all documents

10.5 Add the following as 10.5

Damage to the works

- a) Without in any way limiting the **contractor's** obligations in terms of the contract, the **contractor** shall bear the full risk of damage to and/or destruction of the **works** by whatever cause during construction of the **works** and hereby indemnifies and holds harmless the **employer** against any such damage. The **contractor** shall take such precautions and **security** measures and other steps for the protection and **security** of the **works** as the **contractor** may deem necessary
- b) The **contractor** shall at all times proceed immediately to remove or dispose of any debris arising from damage to or destruction of the **works** and to rebuild, restore, replace and/or repair the **works**
- c) The **employer** shall carry the risk of damage to or destruction of the **works** and materials paid for by the **employer** that is the result of the excepted risks as set out in 10.6
- d) Where the **employer** bears the risk in terms of this contract, the **contractor** shall, if requested to do so, reinstate any damage or destroyed portions of the **works** and the costs of such reinstatement shall be measured and valued in terms of 32.0 hereof

10.6 Add the following as 10.6

Injury to Persons or loss of or damage to Properties

- a) The **contractor** shall be liable for and hereby indemnifies the **employer** against any liability, loss, claim or proceeding whether arising in common law or by statute, consequent upon personal injuries to or the death of any person whomsoever arising out of or in the course of or caused by the execution of the **works** unless due to any act or neglect of any person for whose actions the **employer** is legally liable
- b) The **contractor** shall be liable for and hereby indemnifies the **employer** against any liability, loss, claim or proceeding consequent upon loss of or damage to any moveable, or immovable or personal property or property contiguous to the **site**, whether belonging to or

under the control of the **employer** or any other body or person, arising out of or in the course of or by reason of the execution of the **works** unless due to any act or neglect of any person for whose actions the **employer** is legally liable

- c) The **contractor** shall upon receiving a contract instruction from the **principal agent** cause the same to be made good in a perfect and workmanlike manner at his own cost and in default thereof the **employer** shall be entitled to cause it to be made good and to recover the cost thereof from the **contractor** or to deduct the same from amounts due to the **contractor**.
- d) The **contractor** shall be responsible for the protection and safety of such portions of the premises placed under his control by the **employer** for the purpose of executing the **works** until the issue of the **certificate of practical completion**.
- e) Where the execution of the **works** involves the risk of removal of or interference with support to adjoining properties including land or structures or any structures to be altered or added to, the **contractor**, shall and will remain adequately insured or insured against the death of or injury to persons or damage to such property consequent on such removal or interference with the support until such portion of the **works** has been completed
- f) The **contractor** shall at all times proceed immediately at his own cost to remove or dispose of any debris and to rebuild, restore, replace and/or repair such property and to execute the **works**

10.7 Add the following as 10.7

HIGH RISK INSURANCE

In the event of the project being executed in a geological area classified as a "High Risk Area", that is an area which is subject to highly unstable subsurface conditions that might result in catastrophic ground movement evident by sinkhole or doline formation the following will apply:

10.7.1 Damage to the works

The **contractor** shall, from the **commencement date** of the **works** until the date of the **certificate of practical completion**, bear the full risk of and hereby indemnifies and holds harmless the **employer** against any damage to and/or destruction of the **works** consequent upon a catastrophic ground movement as mentioned above. The **contractor** shall take such precautions and **security** measures and other steps for the protection of the **works** as he may deem necessary

When so instructed to do so by the **principal agent**, the **contractor** shall proceed immediately to remove and/or dispose of any debris arising from damage to or destruction of the **works** and to rebuild, restore, replace and/or repair the **works**, at the **contractor's** own costs

10.7.2 Injury to persons or loss of or damage to property

The **contractor** shall be liable for and hereby indemnifies and holds harmless the **employer** against any liability, loss, claim or proceeding arising at any time during the period of the contract whether arising in common law or by statute, consequent upon personal injuries to or the death of any person whomsoever resulting from, arising out of or caused by a catastrophic ground movement as mentioned above

The **contractor** shall be liable for and hereby indemnifies the **employer** against any and all liability, loss, claim or proceeding consequent upon loss of or damage to any moveable, or immovable or personal property or property contiguous to the site, whether belonging to or under the control of the **employer** or any other body or person whomsoever arising out of or caused by a catastrophic ground movement, as mentioned above, which occurred during the period of the contract

10.7.3 It is the responsibility of the **contractor** to ensure that he has adequate insurance to cover his risk and liability as mentioned in 10.7.1 and 10.7.2. Without limiting the

contractor's obligations in terms of the contract, the **contractor** shall, within twenty one (21) calendar days of the **commencement date** but before commencement of the **works**, submit to the **employer** proof of such insurance policy, if requested to do so

10.7.4 The **employer** shall be entitled to recover any and all losses and/or damages of whatever nature suffered or incurred consequent upon the **contractor's** default of his obligations as set out in 10.7.1; 10.7.2 and 10.7.3. Such losses or damages may be recovered from the **contractor** or by deducting the same from any amounts still due under this contract or under any other contract presently or hereafter existing between the **employer** and the **contractor** and for this purpose all these contracts shall be considered one indivisible whole

14.0 Replace the entire clause 14.0 with the following:

14.0 **SECURITY**

14.1 In respect of contracts with a **contract sum** up to R1 million, the **security** to be submitted by the **contractor** to the **employer** will be as a payment reduction of five percent (5%) of the value certified in the **payment certificate** (excluding VAT)

14.1.1 The payment reduction of the value certified in a **payment certificate** shall be mutatis mutandi in terms of 31.8(A)

14.1.2 The **employer** shall be entitled to recover expense and loss from the payment reduction in terms of 33.0 provided that the **employer** complies with the provisions of 33.4 in which event the **employer's** entitlement shall take precedence over his obligations to refund the payment reduction **security** or portions thereof to the **contractor**

14.2 In respect of contracts with a **contract sum** above R1 million, the **contractor** shall have the right to select the **security** to be provided in terms of 14.3, 14.4, 14.5, 14.6, or 14.7 as stated in the schedule. Such **security** shall be provided to the **employer** within fourteen (14) calendar days from **commencement date**. Should the **contractor** fail to select the **security** to be provided or should the **contractor** fail to provide the **employer** with the selected **security** within fourteen (14) calendar days from **commencement date**, the **security** in terms of 14.7 shall be deemed to have been selected.

14.3 Where the **security** as a cash deposit of ten percent (10%) of the **contract sum** (excluding VAT) has been selected:

14.3.1 The **contractor** shall furnish the **employer** with a cash deposit equal in value to ten percent (10%) of the **contract sum** (excluding VAT) within fourteen (14) calendar days from **commencement date**

14.3.2 Within fourteen (14) calendar days of the date of **practical completion** of the **works** the **employer** shall reduce the cash deposit to an amount equal to three percent (3%) of the contract value (excluding VAT), and refund the balance to the **contractor**

14.3.3 Within fourteen (14) calendar days of the date of **final completion** of the **works** the **employer** shall reduce the cash deposit to an amount equal to one percent (1%) of the contract value (excluding VAT) and refund the balance to the **contractor**

14.3.4 On the date of payment of the amount in the final **payment certificate**, the **employer** shall refund the remainder of the cash deposit to the **contractor**

14.3.5 The **employer** shall be entitled to recover expense and loss from the cash deposit in terms of 33.0 provided that the **employer** complies with the provisions of 33.4 in which event the **employer's** entitlement shall take precedence over his obligations to refund the cash deposit **security** or portions thereof to the **contractor**

14.3.6 The parties expressly agree that neither the **employer** nor the **contractor** shall be entitled to cede the rights to the deposit to any third party

- 14.4 Where **security** as a variable **construction guarantee** of ten percent (10%) of the **contract sum** (excluding VAT) has been selected: **NOT APPLICABLE**
- 14.4.1 The **contractor** shall furnish the **employer** with an acceptable variable **construction guarantee** equal in value to ten percent (10%) of the **contract sum** (excluding VAT) within fourteen (14) calendar days from **commencement date**
- 14.4.2 The variable **construction guarantee** shall reduce and expire in terms of the Variable **Construction guarantee** form included in the invitation to Bidder
- 14.4.3 The **employer** shall return the variable **construction guarantee** to the **contractor** within fourteen (14) calendar days of it expiring
- 14.4.4 Where the **employer** has a right of recovery against the **contractor** in terms of 33.0, the **employer** shall issue a written demand in terms of the variable **construction guarantee**
- 14.5 Where **security** as a fixed **construction guarantee** of five percent (5%) of the **contract sum** (excluding VAT) and a five percent (5%) payment reduction of the value certified in the **payment certificate** (excluding VAT) has been selected:
- 14.5.1 The **contractor** shall furnish a fixed **construction guarantee** to the **employer** equal in value to five percent (5%) of the **contract sum** (excluding VAT) within fourteen (14) calendar days from **commencement date**
- 14.5.2 The fixed **construction guarantee** shall come into force on the date of issue and shall expire on the date of the last **certificate of practical completion**
- 14.5.3 The **employer** shall return the fixed **construction guarantee** to the **contractor** within fourteen (14) calendar days of it expiring
- 14.5.4 The payment reduction of the value certified in a **payment certificate** shall be in terms of 31.8(A) and 34.8
- 14.5.5 Where the **employer** has a right of recovery against the **contractor** in terms of 33.0, the **employer** shall be entitled to issue a written demand in terms of the fixed **construction guarantee** or may recover from the payment reduction or may do both
- 14.6 Where **security** as a cash deposit of five percent (5%) of the **contract sum** (excluding VAT) and a payment reduction of five percent (5%) of the value certified in the **payment certificate** (excluding VAT) has been selected:
- 14.6.1 The **contractor** shall furnish the **employer** with a cash deposit equal in value to five percent (5%) of the **contract sum** (excluding VAT) within fourteen (14) calendar days from **commencement date**
- 14.6.2 Within twenty-one (21) calendar days of the date of **practical completion** of the **works** the **employer** shall refund the cash deposit in total to the **contractor**
- 14.6.3 The payment reduction of the value certified in a **payment certificate** shall be mutatis mutandi in terms of 31.8(A)
- 14.6.4 Where the **employer** has a right of recovery against the **contractor** in terms of 33.0, the **employer** may issue a written notice in terms of 33.4 or may recover from the payment reduction or may do both
- 14.7 Where **security** as a payment reduction of ten percent (10%) of the value certified in the **payment certificate** (excluding VAT) has been selected:
- 14.7.1 The payment reduction of the value certified in a **payment certificate** shall be mutatis mutandi in terms of 31.8(B)
- 14.7.2 The **employer** shall be entitled to recover expense and loss from the payment reduction in terms of 33.0 provided that the **employer** complies with the provisions

of 33.4 in which event the **employer's** entitlement shall take precedence over his obligations to refund the payment reduction or portions thereof to the **contractor**

- 14.8 Payments made by the guarantor to the **employer** in terms of the fixed or variable **construction guarantee** shall not prejudice the rights of the **employer** or **contractor** in terms of this agreement
- 14.9 Should the **contractor** fail to furnish the **security** in terms of 14.2 the **employer**, in his sole discretion, and without notification to the **contractor**, is entitled to change the **contractor's** selected form of **security** to that of a ten percent (10%) payment reduction of the value certified in the **payment certificate** (excluding VAT), whereafter 14.7 shall be applicable
- 15.1.1 No clause
- 15.1.4 Add 15.1.4 as follows:
- An acceptable health and safety plan, required in terms of the Occupational Health and Safety Act, 1993 (Act 85 of 1993), within fourteen (14) calendar days of **commencement date**.
- The abovementioned plan shall also address all additional requirements with regard to the Coronavirus pandemic in terms of all Covid-19 legislation, regulations and guidelines as an additional safe work procedure on site.
- 15.2.1 Under 41: Amend to read as follows:
- "Give the **contractor** possession of the site within five (5) working days of the **contractor** complying with the terms of 15.1.2 and 15.1.4
- 17.1.11 Delete the words "and the appointment of **nominated** and **selected subcontractors**"
- 20.1.3 No clause
- 21.0 No clause
- 29.2.5 No clause
- 31.5.2 Security adjustments in terms of 14.0 and 31.8
- 31.1.4 Add 15.1.4 as follows:
- 31.6 The value of materials and goods in terms of 31.4.2 shall be included in the value certified only where, to the satisfaction of the principal agent, the materials and goods are:
- 31.6.5 Add 31.6.5 as follows:
- Covered by an advance payment guarantee or such other security as may be accepted by the employer where stored off the site. Standard JBCC Guarantee wording would be applicable.
- 31.8 Amend as follows:
- 31.8(A) Where a **security** is selected in terms of 14.1; 14.5 or 14.6, the value of the **works** in terms of 31.4.1 and of the **materials and goods** in terms of 31.4.2 shall be certified in full. The value certified shall be subject to the following percentage adjustments:
- 31.8(A).1 Ninety-five percent (95%) of such value in interim **payment certificates** issued up to the date of **practical completion**
- 31.8(A).2 Ninety-seven percent (97%) of such value in interim **payment certificates** issued on the date of **practical completion** and up to but excluding the date of **final completion**

	<p>31.8(A).3 Ninety-nine percent (99%) of such value in interim payment certificates issued on the date of final completion and up to but excluding the final payment certificate in terms of 34.6</p> <p>31.8(A).4 One hundred percent (100%) of such value in the final payment certificate in terms of 34.6 except where the amount certified is in favour of the employer. In such an event the payment reduction shall remain at the adjustment level applicable to the final payment certificate.</p> <p>31.8(B) Where security is a payment reduction in term of 14.7 has been selected the value of the works in terms of 31.4.1 and materials and goods in terms of 31.4.2 shall be certified in full. The value certified shall be subject to the following percentage adjustments:</p> <p>31.8(B).1 Ninety percent (90%) of such value in interim payment certificates issued up to the date of practical completion</p> <p>31.8(B).2 Ninety-seven percent (97%) of such value in interim payment certificates issued on the date of practical completion and up to but excluding the date of final completion</p> <p>31.8(B).3 Ninety-nine percent (99%) of such value in interim payment certificates issued on the date of final completion and up to but excluding the final payment certificate in terms of 34.6</p> <p>31.8(B).4 One hundred percent (100%) of such value in the final payment certificate in terms of 34.6 except were the amount certified is in favour of the employer. In such an event the payment reduction shall remain at the adjustment level applicable to the final payment certificate</p> <p>31.9 Replace “twenty-one (21) calendar days” with “thirty (30) calendar days”. Should the Contractor’s tax clearance certificate expire during the contract period, the Employer shall be entitled to withhold payment without incurring any liability for interest, until a valid tax clearance certificate is submitted to the Employer, at which point, upon that date, the thirty (30) day period for due date of payment of the invoice shall commence.</p> <p>31.12 Delete the following: “Payment shall be subject to the employer giving the contractor a tax invoice for the amount due.”</p> <p>32.5.1 Add the following to the end of each of these clauses: “...due to no fault of the 32.5.4 contractor” and 32.5.7</p> <p>32.12 Replace “contractor” with “employer”</p> <p>33.2 Add the following clauses 33.2.9 to 33.2.13:</p> <p>33.2.9 the contractor’s failure or neglect to commence with the works on the dates prescribed in the contract</p> <p>33.2.10 the contractor’s failure or neglect to proceed with the works in terms of the contract</p> <p>33.2.11 the contractor’s failure or neglect for any reason to complete the works in accordance with the contract</p> <p>33.2.12 the contractor’s refusal or neglect to comply strictly with any of the conditions of contract or any contract instructions and/or orders in writing given in terms of the contract</p> <p>33.2.13 the contractor’s estate being sequestrated, liquidated or surrendered in terms of the insolvency laws in force within the Republic of South Africa</p>
--	---

	<p>34.13 Replace “seven (7) calendar days” with “thirty (30) calendar days” and delete the words: “subject to the employer giving the contractor a tax invoice for the amount due” as per PPPFA</p> <p>36.3 Remove reference to “No clause”, and replace “principal agent” with “employer”</p> <p>36.7 Add the following: “Notwithstanding any clause to the contrary, on cancellation of this 37.5 this agreement either by the employer or the contractor; or for any reason whatsoever and whatsoever, the contractor shall on written instruction, discontinue with the works on a 38.7 date stated and withdraw himself from the site. The contractor shall not be entitled to refuse to withdraw from the works on the grounds of any lien or right of retention or on the grounds of any other right whatsoever”</p> <p>37.3.5 Replace “ninety (90)” with “one hundred and twenty (120) and 38.5.4</p> <p>39.3.5 Add the following words at the end thereof: :”within one hundred and twenty (120) working days of completion of such report”</p> <p>40.2.2 under clause 41 – Replace “one (1) year” with “three (3) years”</p> <p>40.6 under clause 41 – Remove reference to no clause</p> <p>40.7.1 Change “(10)” to “(15)”</p> <p>Add the following to the end thereof:</p> <p>Whether or not mediation resolves the dispute, the parties shall bear their own costs concerning the mediation and equally share the costs of the mediator and related costs.</p>
42.0	PART 2: CONTRACT DATA PROVIDED BY THE CONTRACTOR
42.0.1	The successful contractor must have a built environment professional on his staff or he must employ one for the duration of the contract.
42.0.2	All bids shall remain valid for a period of one hundred and twenty (120) calendar days after the Request for Quotation closing date.
42.0.3	The successful bidder will be required to submit an Approved Health and Safety File within fourteen (14) calendar days upon receipt of the letter of award.
42.0.4	The successful bidder will be required to submit a letter of good standing from the compensation commission or FEMA within fourteen (14) calendar days upon receipt of the letter of award.
42.0.5	The successful Bidder will be required to submit a construction program and contractor’s cash flow within twenty one (21) calendar days upon receipt of the letter of award.
42.0.6	At least thirty percent (30%) of the total labour force employed during the execution of the works , shall be from the local community.
	POST-BID INFORMATION
42.5	CONTRACT DETAILS
42.5.1	<p>Contractor:</p> <p>.....</p> <p>Postal address:</p> <p>.....</p>

	<p>.....</p> <p>.....</p> <p>Tel: Fax: E-mail:</p> <p>TAX / VAT Registration No:</p> <p>Physical address:</p> <p>.....</p> <p>.....</p> <p>.....</p>								
42.5.2	<p>The accepted contract sum inclusive of tax is</p> <p>R.....</p> <p>Amount in words:</p> <p>.....</p>								
42.5.3 [31.3]	<p>The latest day of the month for the issue of an interim payment certificate:</p> <p>.....</p>								
42.5.4 [32.12]	<p>The preliminaries amounts shall be paid in terms of: Alternative A <input checked="" type="checkbox"/> Alternative B <input type="checkbox"/></p>								
42.5.5 [32.12]	<p>The preliminaries amounts shall be adjusted in terms of: Alternative A <input checked="" type="checkbox"/> Alternative B <input type="checkbox"/></p>								
42.5.7 [14]	<p>The security to be provided by the contractor:</p> <p>(a) in respect of contracts up to R1 million, the contractor will provide security in terms of 14.1</p> <p>(b) in respect of contracts above R1 million, the contractor will provide, as security, one of the following:</p> <table border="1"> <tr> <td>(1) cash deposit of 10% of the contract sum (excluding VAT)</td> <td>Yes <input type="checkbox"/> No <input type="checkbox"/></td> </tr> <tr> <td>(2) payment reduction of 10% of the value certified in the payment certificate (excluding VAT)</td> <td>Yes <input type="checkbox"/> No <input type="checkbox"/></td> </tr> <tr> <td>(3) cash deposit of 5% of the contract sum (excluding VAT) and a payment reduction of 5% of the value certified in the payment certificate (excluding VAT)</td> <td>Yes <input type="checkbox"/> No <input type="checkbox"/></td> </tr> <tr> <td>(4) fixed construction guarantee of 5% of the contract sum (excluding VAT) and a payment reduction of 5% of the value certified in the payment certificate (excluding VAT)</td> <td>Yes <input type="checkbox"/> No <input type="checkbox"/></td> </tr> </table> <p>NB: Guarantees submitted must be issued by either an insurance company duly registered in terms of the Short-Term Insurance Act, 1998 (Act 35 of 1998) or by a bank duly registered in terms of the Banks Act, 1990 (Act 94 of 1990) on the pro-forma referred to above. No alterations or amendments of the wording of the pro-forma will be accepted.</p>	(1) cash deposit of 10% of the contract sum (excluding VAT)	Yes <input type="checkbox"/> No <input type="checkbox"/>	(2) payment reduction of 10% of the value certified in the payment certificate (excluding VAT)	Yes <input type="checkbox"/> No <input type="checkbox"/>	(3) cash deposit of 5% of the contract sum (excluding VAT) and a payment reduction of 5% of the value certified in the payment certificate (excluding VAT)	Yes <input type="checkbox"/> No <input type="checkbox"/>	(4) fixed construction guarantee of 5% of the contract sum (excluding VAT) and a payment reduction of 5% of the value certified in the payment certificate (excluding VAT)	Yes <input type="checkbox"/> No <input type="checkbox"/>
(1) cash deposit of 10% of the contract sum (excluding VAT)	Yes <input type="checkbox"/> No <input type="checkbox"/>								
(2) payment reduction of 10% of the value certified in the payment certificate (excluding VAT)	Yes <input type="checkbox"/> No <input type="checkbox"/>								
(3) cash deposit of 5% of the contract sum (excluding VAT) and a payment reduction of 5% of the value certified in the payment certificate (excluding VAT)	Yes <input type="checkbox"/> No <input type="checkbox"/>								
(4) fixed construction guarantee of 5% of the contract sum (excluding VAT) and a payment reduction of 5% of the value certified in the payment certificate (excluding VAT)	Yes <input type="checkbox"/> No <input type="checkbox"/>								
42.5.8	<p>The annual building holiday period after the commencement of the construction period:</p>								

[29.7.2] from to

<p>42.6</p> <p>42.6.1</p>	<p>DOCUMENTS</p> <p>Contract documents marked and annexed hereto:</p> <table border="1" style="width: 100%; border-collapse: collapse;"> <tr> <td style="width: 35%;">Priced bills of quantities:</td> <td style="width: 20%;">Yes <input type="checkbox"/> No <input type="checkbox"/></td> <td style="width: 45%;">Document marked as</td> </tr> <tr> <td>Lump sum document:</td> <td>Yes <input type="checkbox"/> No <input type="checkbox"/></td> <td>Document marked as</td> </tr> <tr> <td>Guarantees:</td> <td>Yes <input type="checkbox"/> No <input type="checkbox"/></td> <td>Document marked as</td> </tr> <tr> <td>Contract drawings:</td> <td>Yes <input type="checkbox"/> No <input type="checkbox"/></td> <td>Document marked as</td> </tr> <tr> <td>Other documents</td> <td>Yes <input type="checkbox"/> No <input type="checkbox"/></td> <td>(attach additional pages if more space is required)</td> </tr> </table> <p>.....</p> <p>.....</p> <p>.....</p> <p>.....</p> <p>.....</p> <p>.....</p> <p>.....</p> <p>.....</p>	Priced bills of quantities:	Yes <input type="checkbox"/> No <input type="checkbox"/>	Document marked as	Lump sum document:	Yes <input type="checkbox"/> No <input type="checkbox"/>	Document marked as	Guarantees:	Yes <input type="checkbox"/> No <input type="checkbox"/>	Document marked as	Contract drawings:	Yes <input type="checkbox"/> No <input type="checkbox"/>	Document marked as	Other documents	Yes <input type="checkbox"/> No <input type="checkbox"/>	(attach additional pages if more space is required)
Priced bills of quantities:	Yes <input type="checkbox"/> No <input type="checkbox"/>	Document marked as														
Lump sum document:	Yes <input type="checkbox"/> No <input type="checkbox"/>	Document marked as														
Guarantees:	Yes <input type="checkbox"/> No <input type="checkbox"/>	Document marked as														
Contract drawings:	Yes <input type="checkbox"/> No <input type="checkbox"/>	Document marked as														
Other documents	Yes <input type="checkbox"/> No <input type="checkbox"/>	(attach additional pages if more space is required)														

42.8	<p align="center">SIGNATURES OF THE CONTRACTING PARTIES</p> <p>Thus done and signed at _____ on _____</p> <table style="width: 100%; border: none;"> <tr> <td style="width: 50%; border: none;"> <p>_____ Name of signatory</p> <p>_____ Capacity of signatory</p> </td> <td style="width: 50%; border: none; vertical-align: top;"> <p>_____ for and behalf of the Employer who by signature hereof warrants authorization hereto</p> <p>_____ as Witness</p> </td> </tr> </table> <p>Thus done and signed at _____ on _____</p> <table style="width: 100%; border: none;"> <tr> <td style="width: 50%; border: none;"> <p>_____ Name of signatory</p> <p>_____ Capacity of signatory</p> </td> <td style="width: 50%; border: none; vertical-align: top;"> <p>_____ for and behalf of the Contractor who by signature hereof warrants authorization hereto</p> <p>_____ as Witness</p> </td> </tr> </table>	<p>_____ Name of signatory</p> <p>_____ Capacity of signatory</p>	<p>_____ for and behalf of the Employer who by signature hereof warrants authorization hereto</p> <p>_____ as Witness</p>	<p>_____ Name of signatory</p> <p>_____ Capacity of signatory</p>	<p>_____ for and behalf of the Contractor who by signature hereof warrants authorization hereto</p> <p>_____ as Witness</p>
<p>_____ Name of signatory</p> <p>_____ Capacity of signatory</p>	<p>_____ for and behalf of the Employer who by signature hereof warrants authorization hereto</p> <p>_____ as Witness</p>				
<p>_____ Name of signatory</p> <p>_____ Capacity of signatory</p>	<p>_____ for and behalf of the Contractor who by signature hereof warrants authorization hereto</p> <p>_____ as Witness</p>				

--	--

C1.3 Form of Guarantee

C 1.3.1: FIXED CONSTRUCTION GUARANTEE - JBCC 2000 PRINCIPAL BUILDING AGREEMENT (Edition 4.1 of March 2005)

Project title:	PREFABRICATED STRUCTURE RELIEF PROGRAMME: SUPPLY AND ERECT TWO CLASSROOM BLOCK AT AMAZIZI SENIOR SECONDARY SCHOOL	
Request for Quotation No:	2022/07/065	

1. With reference to the contract between _____
_____ (hereinafter referred to as the
“**contractor**”) and the **Eastern Cape Department of Education** (hereinafter referred to as the “**employer**”).
Request for Quotation No: **2022/07/065** for the **PREFABRICATED STRUCTURE RELIEF PROGRAMME:
SUPPLY AND ERECT TWO CLASSROOM BLOCK AT AMAZIZI SENIOR SECONDARY SCHOOL** (hereinafter
referred to as the “contract”)
- in the amount of R _____, (_____
_____) (amount in words),
(hereinafter referred to as the **contract sum** excluding VAT.)
- I/We, _____
in my/our capacity as _____ and hereby
representing _____ (hereinafter
referred to as the **guarantor**”) advise that the **guarantor** hold at the **employer’s** disposal the sum of
R _____ (_____)
(amount in words) being 5% of the **contract sum** (excluding VAT), for the due fulfilment of the contract.
2. The **guarantor** hereby renounces the benefits of the exceptions non numeratae pecunia, non causa debiti;
excussionis et divisionis; and all other exceptions which could be pleaded against the enforcement of this
guarantee, with the meaning and effect whereof i/we declare myself/ourselves to be conversant, and
undertake to pay the **employer** the amount guaranteed, during the period when the claim is received by
the **guarantor**, on receipt of a written demand from the **employer** to do so, and which demand the
employer may make if the **employer** has a right of recovery against the **contractor** in terms of 33.0 of
the contract.
3. Subject to the above, but without in any way detracting from the **employer’s** rights to adopt any of the
procedures provided for in the contract, the said demand can be made by the **employer**, at any stage prior
to the expiry of this guarantee.
4. The amount paid by the **guarantor** in terms of this guarantee may be retained by the **employer** on
condition that upon the issue of the last final **payment certificate**, the **employer** shall account to the
guarantor showing how this amount has been expended and refund any balance due to the **guarantor**.
5. The **employer** shall have the absolute right to arrange his affairs with the **contractor** in any manner which
the **employer** deems fit and the **guarantor** shall not have the right to claim his release on account of any
conduct alleged to be prejudicial to the **guarantor**. Without derogating from the foregoing, any
compromise, extension of the **construction period**, indulgence, release or variation of the **contractor’s**
obligation shall not affect the validity of this guarantee.
6. This undertaking is neither negotiable nor transferable, and
- a) must be surrendered to the **guarantor** at the time when the **employer** accounts to the **guarantor** in
terms of clause 4 above, or
 - b) shall lapse on the date of the last **certificate of practical completion**; and

c) shall not be interpreted as extending the **guarantor's** liability to anything more than payment of the amount guaranteed.

SIGNED AT _____ **ON THIS** _____ **DAY OF** _____ **20** _____

AS WITNESS

1. _____

2. _____

By and on behalf of

(insert the name and physical address of the guarantor)

NAME: _____

CAPACITY: _____
(duly authorized thereto by resolution attached marked Annexure A)

DATE: _____

- A. No alterations and/or additions of the wording of this form will be accepted.
- B. The physical address of the guarantor must be clearly indicated and will be regarded as the guarantor's *domicilium citandi et executandi*, for all purposes arising from this guarantee.
- C. This GUARANTEE must be returned to:

Part 3: Returnable Schedules/Documents

T2.1 List of Returnable Documents

2.1: LIST OF RETURNABLE DOCUMENTS

Project title:	PREFABRICATED STRUCTURE RELIEF PROGRAMME: SUPPLY AND ERECT TWO CLASSROOM BLOCK AT AMAZI SENIOR SECONDARY SCHOOL		
Principal Agent:	Eastern Cape Province Department of Education	Request for Quotation No:	2022/07/065

1. RETURNABLE DOCUMENTS REQUIRED FOR TENDER EVALUATION PURPOSES

(Insert a tick in the "Returnable document" column to indicate which documents must be returned with the Bid)

Bid Document Name	Number of pages issued	Returnable Document
Declaration of Interest (SBD4)	3 Pages	<input checked="" type="checkbox"/> Yes <input type="checkbox"/> No
Preference points claim form in terms of Preferential Procurement Regulations 2017 (SBD 6.1)	6 Pages	<input checked="" type="checkbox"/> Yes <input type="checkbox"/> No
Local Production and Content (SBD 6.2)	7 Pages	<input checked="" type="checkbox"/> Yes <input type="checkbox"/> No
Certificate of Authority for Signatory (T2.2.1)	1 Page	<input checked="" type="checkbox"/> Yes <input type="checkbox"/> No
Certificate of Authority for Joint Ventures (T2.2.2)	1 Page	<input checked="" type="checkbox"/> Yes <input type="checkbox"/> No
Schedule of Proposed Subcontractors (T2.2.3)	1 Page	<input type="checkbox"/> Yes <input checked="" type="checkbox"/> No
Final Summary Page of Bills of Quantities (C1.1a)	1 Page	<input checked="" type="checkbox"/> Yes <input type="checkbox"/> No
Completed Project Reference Forms (T2.2.13)	6 Pages	<input checked="" type="checkbox"/> Yes <input type="checkbox"/> No

2. OTHER DOCUMENTS REQUIRED FOR REQUEST FOR QUOTATION EVALUATION PURPOSES

Bid Document Name	Number of pages issued	Returnable Document
Site Inspection Certificate (T2.2.4)	1 Page	<input type="checkbox"/> Yes <input checked="" type="checkbox"/> No
Capacity of the Bidder (T2.2.6)	1 Page	<input checked="" type="checkbox"/> Yes <input type="checkbox"/> No
Relevant Project Experience - Completed Projects (T2.2.7)	1 Page	<input checked="" type="checkbox"/> Yes <input type="checkbox"/> No
Relevant Project Experience - Current Projects (T2.2.8)	1 Page	<input checked="" type="checkbox"/> Yes <input type="checkbox"/> No
CIDB Grading Certificate (T2.2.11)	1 Page	<input checked="" type="checkbox"/> Yes <input type="checkbox"/> No
CIPC Company Registration Certificate (T2.2.12)	1 Page	<input checked="" type="checkbox"/> Yes <input type="checkbox"/> No
ID's of shareholders, members, partners or sole proprietor (T2.2.12)	1 Page	<input checked="" type="checkbox"/> Yes <input type="checkbox"/> No
Letter of Good Standing from Bank (T2.2.12)	1 Page	<input checked="" type="checkbox"/> Yes <input type="checkbox"/> No
B-BBEE Verification Certificate / Sworn Affidavit (T2.2.12)	1 Page	<input checked="" type="checkbox"/> Yes <input type="checkbox"/> No
Letter of Good Standing from Compensation Fund (T2.2.12)	1 Page	<input checked="" type="checkbox"/> Yes <input type="checkbox"/> No
CSD Registration Summary Report (T2.2.12)	1 Page	<input checked="" type="checkbox"/> Yes <input type="checkbox"/> No
SARS Tax Clearance Certificate and Pin (T2.2.12)	1 Page	<input checked="" type="checkbox"/> Yes <input type="checkbox"/> No

Proof of Locality of Head Office (T2.2.12)	1 Page	<input checked="" type="checkbox"/> Yes <input type="checkbox"/> No
--	--------	---

3. RETURNABLE DOCUMENTS THAT WILL BE INCORPORATED INTO THE CONTRACT

Bid Document Name	Number of pages issued	Returnable Document
Record of Addenda to Request for Quotation Documents (T2.2.5)	1 Page	<input checked="" type="checkbox"/> Yes <input type="checkbox"/> No
Schedule of Plant and Equipment (T2.2.9)	1 Page	<input checked="" type="checkbox"/> Yes <input type="checkbox"/> No
Compulsory Enterprise Questionnaire (T2.2.10)	1 Page	<input checked="" type="checkbox"/> Yes <input type="checkbox"/> No

4. OTHER DOCUMENTS THAT WILL BE INCORPORATED INTO THE CONTRACT

Bid Document Name	Number of pages issued	Returnable Document
Form of Offer and Acceptance (C1.1)	3 Pages	<input checked="" type="checkbox"/> Yes <input type="checkbox"/> No
Contract Data (C1.2)	14 Pages	<input checked="" type="checkbox"/> Yes <input type="checkbox"/> No
Applicable form of Guarantee (C1.3)	4 Pages	<input type="checkbox"/> Yes <input checked="" type="checkbox"/> No
Priced Bills of Quantities including Preliminaries (C2.2)	90 Pages	<input checked="" type="checkbox"/> Yes <input type="checkbox"/> No

T2.2 Returnable schedules

SBD 4 : BIDDER'S DISCLOSURE

BIDDER'S DISCLOSURE

1. PURPOSE OF THE FORM

Any person (natural or juristic) may make an offer or offers in terms of this invitation to bid. In line with the principles of transparency, accountability, impartiality, and ethics as enshrined in the Constitution of the Republic of South Africa and further expressed in various pieces of legislation, it is required for the bidder to make this declaration in respect of the details required hereunder.

Where a person/s are listed in the Register for Tender Defaulters and / or the List of Restricted Suppliers, that person will automatically be disqualified from the bid process.

2. Bidder's declaration

2.1 Is the bidder, or any of its directors / trustees / shareholders / members / partners or any person having a controlling interest¹ in the enterprise, employed by the state? **YES/NO**

2.1.1 If so, furnish particulars of the names, individual identity numbers, and, if applicable, state employee numbers of sole proprietor/ directors / trustees / shareholders / members/ partners or any person having a controlling interest in the enterprise, in table below.

Full Name	Identity Number	Name of institution	State

2.2 Do you, or any person connected with the bidder, have a relationship with any person who is employed by the procuring institution? **YES/NO**

2.2.1 If so, furnish particulars:

.....
.....

2.3 Does the bidder or any of its directors / trustees / shareholders / members / partners or any person having a controlling interest in the enterprise have any interest in any other related enterprise whether or not they are bidding for this contract?

YES/NO

2.3.1 If so, furnish particulars:

.....
.....

¹ the power, by one person or a group of persons holding the majority of the equity of an enterprise, alternatively, the person/s having the deciding vote or power to influence or to direct the course and decisions of the enterprise.

3 DECLARATION

I, the undersigned, (name)..... in submitting the accompanying bid, do hereby make the following statements that I certify to be true and complete in every respect:

- 3.1 I have read and I understand the contents of this disclosure;
- 3.2 I understand that the accompanying bid will be disqualified if this disclosure is found not to be true and complete in every respect;
- 3.3 The bidder has arrived at the accompanying bid independently from, and without consultation, communication, agreement or arrangement with any competitor. However, communication between partners in a joint venture or consortium² will not be construed as collusive bidding.
- 3.4 In addition, there have been no consultations, communications, agreements or arrangements with any competitor regarding the quality, quantity, specifications, prices, including methods, factors or formulas used to calculate prices, market allocation, the intention or decision to submit or not to submit the bid, bidding with the intention not to win the bid and conditions or delivery particulars of the products or services to which this bid invitation relates.
- 3.4 The terms of the accompanying bid have not been, and will not be, disclosed by the bidder, directly or indirectly, to any competitor, prior to the date and time of the official bid opening or of the awarding of the contract.
- 3.5 There have been no consultations, communications, agreements or arrangements made by the bidder with any official of the procuring institution in relation to this procurement process prior to and during the bidding process except to provide clarification on the bid submitted where so required by the institution; and the bidder was not involved in the drafting of the specifications or terms of reference for this bid.
- 3.6 I am aware that, in addition and without prejudice to any other remedy provided to combat any restrictive practices related to bids and contracts, bids that are suspicious will be reported to the Competition Commission for investigation and possible imposition of administrative penalties in terms of section 59 of the Competition Act No 89 of 1998 and or may be reported to the National Prosecuting Authority (NPA) for criminal investigation and or may be restricted from conducting business with the public sector for a period not exceeding ten (10) years in terms of the Prevention and Combating of Corrupt Activities Act No 12 of 2004 or any other applicable legislation.

I CERTIFY THAT THE INFORMATION FURNISHED IN PARAGRAPHS 1, 2 and 3 ABOVE IS CORRECT.

I ACCEPT THAT THE STATE MAY REJECT THE BID OR ACT AGAINST ME IN TERMS

OF PARAGRAPH 6 OF PFMA SCM INSTRUCTION 03 OF 2021/22 ON PREVENTING AND

COMBATING ABUSE IN THE SUPPLY CHAIN MANAGEMENT SYSTEM SHOULD THIS

DECLARATION PROVE TO BE FALSE.

.....
Signature

.....
Date

.....
Position

.....
Name of bidder

² Joint venture or Consortium means an association of persons for the purpose of combining their expertise, property, capital, efforts, skill and knowledge in an activity for the execution of a contract.

SBD 6.1 : Preference Points Claim Form

SBD 6.1

PREFERENCE POINTS CLAIM FORM

In order to claim preference points, Bidders are to note the following:

- The SBD 6.1 form must be completed and duly signed.
- A valid (current) B-BBEE status level verification certificate substantiating the Bidder's B-BBEE rating and issued by a Registered Auditor approved by SANAS as contemplated in the Close Corporation Act, 1984, (Act No. 69 of 1984) must be submitted with the Request for Quotation.
- EME's with an annual total revenue of R3 million or less, are required to submit a sworn affidavit (Construction Charter) confirming their level of black ownership, etc to claim points.
- In the event of a Joint Venture, a consolidated B-BBEE level verification certificate or sworn affidavit must be submitted to claim points.

SBD 6.1

PREFERENCE POINTS CLAIM FORM IN TERMS OF THE PREFERENTIAL PROCUREMENT REGULATIONS 2017

This preference form must form part of all bids invited. It contains general information and serves as a claim form for preference points for Broad-Based Black Economic Empowerment (B-BBEE) Status Level of Contribution

NB: BEFORE COMPLETING THIS FORM, BIDDERS MUST STUDY THE GENERAL CONDITIONS, DEFINITIONS AND DIRECTIVES APPLICABLE IN RESPECT OF B-BBEE, AS PRESCRIBED IN THE PREFERENTIAL PROCUREMENT REGULATIONS, 2017.

1. GENERAL CONDITIONS

1.1 The following preference point systems are applicable to all bids:

- the 80/20 system for requirements with a Rand value of up to R50 000 000 (all applicable taxes included); and
- the 90/10 system for requirements with a Rand value above R50 000 000 (all applicable taxes included).

1.2

- a) The value of this bid is estimated to ~~exceed~~ not exceed R50 000 000 (all applicable taxes included) and therefore the ...**80/20**... preference point system shall be applicable; or
- b) Either the 80/20 or 90/10 preference point system will be applicable to this tender (*delete whichever is not applicable for this tender*).

1.3 Points for this bid shall be awarded for:

- (a) Price; and
- (b) B-BBEE Status Level of Contributor.

1.4 The maximum points for this bid are allocated as follows:

	POINTS
PRICE	80
B-BBEE STATUS LEVEL OF CONTRIBUTOR	20
Total points for Price and B-BBEE must not exceed	100

1.5 Failure on the part of a bidder to submit proof of B-BBEE Status level of contributor together with the bid, will be interpreted to mean that preference points for B-BBEE status level of contribution are not claimed.

1.6 The purchaser reserves the right to require of a bidder, either before a bid is adjudicated or at any time subsequently, to substantiate any claim in regard to preferences, in any manner required by the purchaser.

4. POINTS AWARDED FOR B-BBEE STATUS LEVEL OF CONTRIBUTOR

4.1 In terms of Regulation 6 (2) and 7 (2) of the Preferential Procurement Regulations, preference points must be awarded to a bidder for attaining the B-BBEE status level of contribution in accordance with the table below:

B-BBEE Status Level of Contributor	Number of points (90/10 system)	Number of points (80/20 system)
1	10	20
2	9	18
3	6	14
4	5	12
5	4	8
6	3	6
7	2	4
8	1	2
Non-compliant contributor	0	0

5. BID DECLARATION

5.1 Bidders who claim points in respect of B-BBEE Status Level of Contribution must complete the following:

6. B-BBEE STATUS LEVEL OF CONTRIBUTOR CLAIMED IN TERMS OF PARAGRAPHS 1.4 AND 4.1

6.1 B-BBEE Status Level of Contributor: = (maximum of 10 or 20 points)
 (Points claimed in respect of paragraph 7.1 must be in accordance with the table reflected in paragraph 4.1 and must be substantiated by relevant proof of B-BBEE status level of contributor.)

7. SUB-CONTRACTING

7.1 Will any portion of the contract be sub-contracted?

(Tick applicable box)

YES	<input type="checkbox"/>	NO	<input type="checkbox"/>
-----	--------------------------	----	--------------------------

7.1.1 If yes, indicate:

- i) What percentage of the contract will be subcontracted.....%
- ii) The name of the sub-contractor.....
- iii) The B-BBEE status level of the sub-contractor.....
- iv) Whether the sub-contractor is an EME or QSE

(Tick applicable box)

YES	<input type="checkbox"/>	NO	<input type="checkbox"/>
-----	--------------------------	----	--------------------------

v) Specify, by ticking the appropriate box, if subcontracting with an enterprise in terms of Preferential Procurement Regulations,2017:

Designated Group: An EME or QSE which is at last 51% owned by:	EME √	QSE √
Black people		
Black people who are youth		
Black people who are women		
Black people with disabilities		
Black people living in rural or underdeveloped areas or townships		
Cooperative owned by black people		
Black people who are military veterans		
OR		
Any EME		
Any QSE		

8. DECLARATION WITH REGARD TO COMPANY/FIRM

8.1 Name of company/firm:.....

8.2 VAT registration number:.....

8.3 Company registration number:.....

8.4 TYPE OF COMPANY/ FIRM

- Partnership/Joint Venture / Consortium
- One person business/sole propriety
- Close corporation
- Company
- (Pty) Limited

[TICK APPLICABLE BOX]

8.5 DESCRIBE PRINCIPAL BUSINESS ACTIVITIES

.....
.....
.....
.....

8.6 COMPANY CLASSIFICATION

- Manufacturer
- Supplier
- Professional service provider
- Other service providers, e.g. transporter, etc.

[TICK APPLICABLE BOX]

8.7 Total number of years the company/firm has been in business:.....

8.8 I/we, the undersigned, who is / are duly authorised to do so on behalf of the company/firm, certify that the points claimed, based on the B-BBE status level of contributor indicated in paragraphs 1.4 and 6.1 of the foregoing certificate, qualifies the company/ firm for the preference(s) shown and I / we acknowledge that:

- i) The information furnished is true and correct;
- ii) The preference points claimed are in accordance with the General Conditions as indicated in paragraph 1 of this form;
- iii) In the event of a contract being awarded as a result of points claimed as shown in

paragraphs 1.4 and 6.1, the contractor may be required to furnish documentary proof to the satisfaction of the purchaser that the claims are correct;

iv) If the B-BBEE status level of contributor has been claimed or obtained on a fraudulent basis or any of the conditions of contract have not been fulfilled, the purchaser may, in addition to any other remedy it may have –

- (a) disqualify the person from the bidding process;
- (b) recover costs, losses or damages it has incurred or suffered as a result of that person's conduct;
- (c) cancel the contract and claim any damages which it has suffered as a result of having to make less favourable arrangements due to such cancellation;
- (d) recommend that the bidder or contractor, its shareholders and directors, or only the shareholders and directors who acted on a fraudulent basis, be restricted by the National Treasury from obtaining business from any organ of state for a period not exceeding 10 years, after the *audi alteram partem* (hear the other side) rule has been applied; and
- (e) forward the matter for criminal prosecution.

<p>WITNESSES</p> <p>1.</p> <p>2.</p>

<p>.....</p> <p>SIGNATURE(S) OF BIDDERS(S)</p> <p>DATE:</p> <p>ADDRESS</p> <p>.....</p> <p>.....</p>
--

SBD 6.2: Local Production and Content

SBD 6.2

DECLARATION CERTIFICATE FOR LOCAL PRODUCTION AND CONTENT FOR DESIGNATED SECTORS

This Standard Bidding Document (SBD) must form part of all bids invited. It contains general information and serves as a declaration form for local content (local production and local content are used interchangeably).

Before completing this declaration, bidders must study the General Conditions, Definitions, Directives applicable in respect of Local Content as prescribed in the Preferential Procurement Regulations, 2017, the South African Bureau of Standards (SABS) approved technical specification number SATS 1286:2011 (Edition 1) and the Guidance on the Calculation of Local Content together with the Local Content Declaration Templates [Annex C (Local Content Declaration: Summary Schedule), D (Imported Content Declaration: Supporting Schedule to Annex C) and E (Local Content Declaration: Supporting Schedule to Annex C)].

1. General Conditions

- 1.1. Preferential Procurement Regulations, 2017 (Regulation 8) make provision for the promotion of local production and content.
- 1.2. Regulation 8.(2) prescribes that in the case of designated sectors, organs of state must advertise such tenders with the specific bidding condition that only locally produced or manufactured goods, with a stipulated minimum threshold for local production and content will be considered.
- 1.3. Where necessary, for tenders referred to in paragraph 1.2 above, a two stage bidding process may be followed, where the first stage involves a minimum threshold for local production and content and the second stage price and B-BBEE.
- 1.4. A person awarded a contract in relation to a designated sector, may not sub-contract in such a manner that the local production and content of the overall value of the contract is reduced to below the stipulated minimum threshold.
- 1.5. The local content (LC) expressed as a percentage of the bid price must be calculated in accordance with the SABS approved technical specification number SATS 1286: 2011 as follows:

$$LC = [1 - x / y] * 100$$

Where

x is the imported content in Rand

y is the bid price in Rand excluding value added tax (VAT)

Prices referred to in the determination of x must be converted to Rand (ZAR) by using the exchange rate published by South African Reserve Bank (SARB) on the date of advertisement of the bid as indicated in paragraph 3.1 below.

The SABS approved technical specification number SATS 1286:2011 is accessible on [http://www.thedti.gov.za/industrial development/ip.jsp](http://www.thedti.gov.za/industrial%20development/ip.jsp) at no cost.

- 1.6. A bid may be disqualified if this Declaration Certificate and the Annex C (Local Content Declaration: Summary Schedule) are not submitted as part of the bid documentation;

2. The stipulated minimum threshold(s) for local production and content (refer to Annex A of SATS 1286:2011) for this bid is/are as follows:

<u>Description of services, works or goods</u>	<u>Stipulated minimum threshold</u>
Reinforcement	100%
Roof coverings	100%
Steel windows, doors and frames	100%
Sundry metalwork and structural steelwork	100%
Gutters and down pipes	100%

uPVC and HDPE pipes	100%
Electrical cables	100%
Fencing	100%

3. Does any portion of the goods or services offered have any imported content?

(Tick applicable box)

YES	<input type="checkbox"/>	NO	<input type="checkbox"/>
-----	--------------------------	----	--------------------------

3.1 If yes, the rate(s) of exchange to be used in this bid to calculate the local content as prescribed in paragraph 1.5 of the general conditions must be the rate(s) published by SARB for the specific currency on the date of advertisement of the bid.

The relevant rates of exchange information is accessible on www.resbank.co.za

Indicate the rate(s) of exchange against the appropriate currency in the table below (refer to Annex A of SATS 1286:2011):

Currency	Rates of exchange
US Dollar	
Pound Sterling	
Euro	
Yen	
Other	

NB: Bidders must submit proof of the SARB rate (s) of exchange used.

4. Where, after the award of a bid, challenges are experienced in meeting the stipulated minimum threshold for local content the dti must be informed accordingly in order for the dti to verify and in consultation with the AO/AA provide directives in this regard.

LOCAL CONTENT DECLARATION
(REFER TO ANNEX B OF SATS 1286:2011)

LOCAL CONTENT DECLARATION BY CHIEF FINANCIAL OFFICER OR OTHER LEGALLY RESPONSIBLE PERSON NOMINATED IN WRITING BY THE CHIEF EXECUTIVE OR SENIOR MEMBER/PERSON WITH MANAGEMENT RESPONSIBILITY (CLOSE CORPORATION, PARTNERSHIP OR INDIVIDUAL)

IN RESPECT OF BID NO.

ISSUED BY: (Procurement Authority / Name of Institution):

NB

- 1 The obligation to complete, duly sign and submit this declaration cannot be transferred to an external authorized representative, auditor or any other third party acting on behalf of the bidder.
- 2 Guidance on the Calculation of Local Content together with Local Content Declaration Templates (Annex C, D and E) is accessible on http://www.thedti.gov.za/industrial_development/ip.jsp. Bidders should first complete Declaration D. After completing Declaration D, bidders should complete Declaration E and then consolidate the information on Declaration C. **Declaration C should be submitted with the bid documentation at the closing date and time of the bid in order to substantiate the declaration made in paragraph (c) below.** Declarations D and E should be kept by the bidders for verification purposes for a period of at least 5 years. The successful bidder is required to continuously update Declarations C, D and E with the actual values for the duration of the contract.

I, the undersigned, (full names),
do hereby declare, in my capacity as
of(name of bidder entity), the
following:

- (a) The facts contained herein are within my own personal knowledge.
- (b) I have satisfied myself that:
 - (i) the goods/services/works to be delivered in terms of the above-specified bid comply with the minimum local content requirements as specified in the bid, and as measured in terms of SATS 1286:2011; and
- (c) The local content percentage (%) indicated below has been calculated using the formula given in clause 3 of SATS 1286:2011, the rates of exchange indicated in paragraph 3.1 above and the information contained in Declaration D and E which has been consolidated in Declaration C:

Bid price, excluding VAT (y)	R
Imported content (x), as calculated in terms of SATS 1286:2011	R
Stipulated minimum threshold for local content (paragraph 3 above)	
Local content %, as calculated in terms of SATS 1286:2011	

If the bid is for more than one product, the local content percentages for each product contained in Declaration C shall be used instead of the table above. The local content percentages for each product has been calculated using the formula given in clause 3 of SATS 1286:2011, the rates of exchange indicated in paragraph 3.1 above and the information contained in Declaration D and E.

- (d) I accept that the Procurement Authority / Institution has the right to request that the local

content be verified in terms of the requirements of SATS 1286:2011.

- (e) I understand that the awarding of the bid is dependent on the accuracy of the information furnished in this application. I also understand that the submission of incorrect data, or data that are not verifiable as described in SATS 1286:2011, may result in the Procurement Authority / Institution imposing any or all of the remedies as provided for in Regulation 14 of the Preferential Procurement Regulations, 2017 promulgated under the Preferential Policy Framework Act (PPPFA), 2000 (Act No. 5 of 2000).

SIGNATURE: _____

WITNESS No. 1 _____

DATE: _____

WITNESS No. 2 _____

DATE: _____

Annexure C

Local Content Declaration – Summary Schedule

(C1)	Tender No.						
(C2)	Tender Description:						
(C3)	Designated product(s)						
(C4)	Tender Authority:						
(C5)	Tender Entity Name:						
(C6)	Tender Exchange Rate:	Pula:		EU:		GBP:	
(C7)	Specified local content %						

Note: VAT to be excluded from all calculations

		Calculation of Local Content						Tender Summary			
Tender item no's	List of items	Tender price – each (excl. VAT)	Exempted imported value	Tender value net of exempted imported content	Imported value	Local value	Local content % (per item)	Tender Qty	Total tender value	Total exempted imported content	Total imported content
(C8)	(C9)	(C10)	(C11)	(C12)	(C13)	(C14)	(C15)	(C16)	(C17)	(C18)	(C19)

Signature of Bidder from Annex B

Date: _____

(C20) Total tender value	
(C21) Total Exempt imported content	
(C22) Total tender value net of exempt imported content	
(C23) Total Imported content	
(C24) Total local content	
(C25) Average local content % of tender	

Annexure D

Imported Content Declaration – Supporting Schedule to Annex C

(D1)	Tender No.						
(D2)	Tender Description:						
(D3)	Designated product(s)						
(D4)	Tender Authority:						
(D5)	Tender Entity Name:						
(D6)	Tender Exchange Rate:	Pula:		EU:		GBP:	

Note: VAT to be excluded from all calculations

A. Exempted imported content

A. Exempted imported content			Calculation of imported content						
Tender Item no's	Description of imported content	Local supplier	Overseas supplier	Foreign currency value as per commercial invoice	Tender Rate of Exchange	Local value of imports	Freight costs to port of entry	All locally incurred landing costs & duties	Total landed cost excl. VAT
(D7)	(D8)	(D9)	(D10)	(D11)	(D12)	(D13)	(D14)	(D15)	(D16)

Summary	
Tender QTY	Exempted imported value
(D17)	(D18)

(D19) Total exempt imported value

This total must correspond with Annex C - C21

B. Imported directly by Tenderer

B. Imported directly by Tenderer			Calculation of imported content						
Tender Item no's	Description of imported content	Unit of measure	Overseas supplier	Foreign currency value as per commercial invoice	Tender Rate of Exchange	Local value of imports	Freight costs to port of entry	All locally incurred landing costs & duties	Total landed cost excl. VAT
(D20)	(D21)	(D22)	(D23)	(D24)	(D25)	(D26)	(D27)	(D28)	(D29)

Summary	
Tender QTY	Total imported value
(D30)	(D31)

(D32) Total imported value by tenderer

C. Imported by a 3rd party and supplied to the Tenderer

C. Imported by a 3 rd party and supplied to the Tenderer			Calculation of imported content						
Description of imported content	Unit of Measure	Local Supplier	Overseas supplier	Foreign currency value as per commercial invoice	Tender Rate of Exchange	Local value of imports	Freight costs to port of entry	All locally incurred landing costs & duties	Total landed cost excl. VAT
(D33)	(D34)	(D35)	(D36)	(D37)	(D38)	(D39)	(D40)	(D42)	(D42)

Summary	
Tender QTY	Total imported value
(D43)	(D44)

(D45) Total imported value by 3rd party

D. Other foreign currency payments

D. Other foreign currency payments			Calculation of foreign currency	
Type of payment	Local Supplier making the payment	Overseas beneficiary	Foreign currency value paid	Tender Rate of Exchange
(D46)	(D47)	(D48)	(D49)	(D50)

Summary of Payments
Local value of payments
(D51)

Signature of tenderer from Annex B

(D52) Total of foreign currency payments by tenderer/or 3rd party

Date: _____

(D53) Total of imported content & foreign currency payments (D32), (D45) & (D52) above

This total must correspond with Annex C – C23

Annexure E

Local Content Declaration – Supporting Schedule to Annex C

(E1)	Tender No.	
(E2)	Tender Description:	
(E3)	Designated product(s)	
(E4)	Tender Authority:	
(E5)	Tender Entity Name:	

Note: VAT to be excluded from all calculations

Local Products (Goods, Services and Works)	Description of items purchased	Local Suppliers	Value
	(E6)	(E7)	(E8)
(E9) Total local products (Goods, Service and Works)			

(E10)	Manpower costs	(Tenderer's manpower cost)	
(E11)	Factory overheads	(Rental, depreciation & amortisation, utility costs, consumables etc.)	
(E12)	Administration overheads and mark-up	(Marketing, insurance, financing, interest etc.)	
(E13) Total local content			

This total must correspond with annex C – C24

Signature of tenderer from Annex B

Date: _____

T2.2.1 Certificate of Authority for Signatory

T2.2.1: CERTIFICATE OF AUTHORITY FOR SIGNATORY

Project title:	PREFABRICATED STRUCTURE RELIEF PROGRAMME: SUPPLY AND ERECT TWO CLASSROOM BLOCK AT AMAZI SENIOR SECONDARY SCHOOL
Request for Quotation No:	2022/07/065

NOTE: This returnable document must be on a company letterhead

Signatory for companies shall confirm their authority hereto by attaching a duly signed and dated copy of the relevant resolution of the board of directors to this form on the company's letterhead.

An example is given below:

"By resolution of the board of directors passed at a meeting held on _____

Mr/Ms _____, whose signature appears below, has been duly authorised to

sign all documents in connection with the bidder for Contract No. _____

and any Contract which may arise there from on behalf of (Block Capitals) _____

SIGNED ON BEHALF OF THE COMPANY: _____

IN HIS/HER CAPACITY AS: _____

DATE: _____

SIGNATURE OF SIGNATORY: _____

WITNESSES:

1. _____ SIGNATURE: _____

2. _____ SIGNATURE: _____

T2.2.2 Certificate of Authority for Joint Ventures

T2.2.2: CERTIFICATE OF AUTHORITY FOR JOINT VENTURES

Project title:	PREFABRICATED STRUCTURE RELIEF PROGRAMME: SUPPLY AND ERECT TWO CLASSROOM BLOCK AT AMAZIZI SENIOR SECONDARY SCHOOL
Request for Quotation No:	2022/07/065

This returnable schedule is to be completed by joint ventures.

We, the undersigned, are submitting this Request for Quotation in Joint Venture and hereby authorise Mr/Ms _____, of the company _____, acting in the capacity of lead partner, to sign all documents in connection with the Request for Quotation and any contract resulting from it on our behalf.

Name of Firm	Address	Duly Authorised Signatory
Lead Partner _____		Signature: _____ Name: _____ Designation: _____
_____		Signature: _____ Name: _____ Designation: _____
_____		Signature: _____ Name: _____ Designation: _____
_____		Signature: _____ Name: _____ Designation: _____

T2.2.5 Record of Addenda to Request for Quotation Documents

T2.2.5: RECORD OF ADDENDA TO BID DOCUMENTS

Project title:	PREFABRICATED STRUCTURE RELIEF PROGRAMME: SUPPLY AND ERECT TWO CLASSROOM BLOCK AT AMAZI SENIOR SECONDARY SCHOOL
Request for Quotation No:	2022/07/065

We confirm that the following communications received from the Employer before the submission of this Request for Quotation offer, amending the Request for Quotation documents, have been taken into account in this Request for Quotation offer:

	Date	Title or Details
1.		
2.		
3.		
4.		
5.		
6.		
7.		
8.		
9.		
10.		

Attach additional pages if more space is required.

Signed _____ Date _____

Name _____ Position _____

Bidder _____

T2.2.6 Capacity of Bidder

T2.2.6: CAPACITY OF THE BIDDER

Project title:	PREFABRICATED STRUCTURE RELIEF PROGRAMME: SUPPLY AND ERECT TWO CLASSROOM BLOCK AT AMAZIZI SENIOR SECONDARY SCHOOL
Request for Quotation No:	2022/07/065
<p>WORK CAPACITY: (The Bidder is requested to furnish the following capacity particulars and to attach additional pages if more space is required. Details of project team including CV, qualifications and proof of registration completed for each individual to be provided by Bidder. Failure to furnish the particulars may result in the Bid being disregarded.)</p> <p><i>Artisans and Employees: (Artisans and Employees to be, or are, employed for this project)</i></p>	

Quantity / No. of Resources	Categories of Employee - Key Personnel (part of Business Enterprise)	Professional Registration No.	Date of Employment
	Site Agent		
	Project Manager		
	Foreman		
	Quality Control & Safety Officer-Construction Supervisor		
	Artisans		
	Unskilled employees		
	Others		

The undersigned, who warrants that she/ he is duly authorised to do so on behalf of the enterprise, confirms that the content of this schedule that presented by the Bidder are within my personal knowledge and are to the best of my knowledge both true and correct.

Signed:	Date:
Name:	Position:
Bidder:			

T2.2.7 Relevant Project Experience - Completed Projects

T2.2.7: RELEVANT PROJECT EXPERIENCE – COMPLETED PROJECTS

Project title:	PREFABRICATED STRUCTURE RELIEF PROGRAMME: SUPPLY AND ERECT TWO CLASSROOM BLOCK AT AMAZI SENIOR SECONDARY SCHOOL
Request for Quotation No:	2022/07/065

Bidders must submit a max one-page description of at least three projects successfully completed.

Attach a Completion Certificate for each of the project provided.

The description of each project must include the following information:

1. Essential introductory information:
 - 1.1. Name of project.
 - 1.2. Name of client.
 - 1.3. Contact details of client.
 - 1.4. Contact details (including telephone numbers and email addresses) of currently contactable references.
 - 1.5. The period during which the project was performed, and also, if this is different, the period during which the Bidder's team members were contracted.
 - 1.6. Cost of works and/or contract value (making it clear in broad terms what this cost/value purchased, and to what extent (if any) this cost/value was part of a larger project budget or programme budget).

NO.	NAME OF PROJECT	NAME OF CLIENT	CONTACT DETAILS OF CLIENT	PROJECT VALUE	DATE COMPLETED
1					
2					
3					

Attach a separate page to address this issue (the above table is just for reference purposes).

The undersigned, who warrants that she/ he is duly authorised to do so on behalf of the enterprise, confirms that the content of this schedule that presented by the Bidder are within my personal knowledge and are to the best of my knowledge both true and correct.

Signed _____ Date _____

Name _____ Position _____

Bidder _____

T2.2.8 Relevant Project Experience - Current Projects

T2.2.8: RELEVANT PROJECT EXPERIENCE – CURRENT PROJECTS

Project title:	PREFABRICATED STRUCTURE RELIEF PROGRAMME: SUPPLY AND ERECT TWO CLASSROOM BLOCK AT AMAZI SENIOR SECONDARY SCHOOL
Request for Quotation No:	2022/07/065

Bidders must submit a max one-page description of at least three projects under construction/ on hold/ just handed over/ towards completion (if they exist).

Attach an Appointment letter for each of the project provided.

The description of each project must include the following information:

2. Essential introductory information:
 - 2.1. Name of project.
 - 2.2. Name of client.
 - 2.3. Contact details of client.
 - 2.4. Contact details (including telephone numbers and email addresses) of currently contactable references.
 - 2.5. The period during which the project was performed, and also, if this is different, the period during which the Bidder's team members were contracted.
 - 2.6. Cost of works and/or contract value (making it clear in broad terms what this cost/value purchased, and to what extent (if any) this cost/value was part of a larger project budget or programme budget).

NO.	NAME OF PROJECT	NAME OF CLIENT	CONTACT DETAILS OF CLIENT	CONTACT DETAILS OF REFERENCES	PROJECT VALUE	STAGE OF PROJECT
1						
2						
3						

Attach a separate page to address this issue (the above table is just for reference purposes).

The undersigned, who warrants that she/ he is duly authorised to do so on behalf of the enterprise, confirms that the content of this schedule that presented by the Bidder are within my personal knowledge and are to the best of my knowledge both true and correct.

Signed _____ Date _____

Name _____ Positi
on _____

Bidder _____

T2.2.9 Schedule of Plant & Equipment

T2.2.9: SCHEDULE OF PLANT AND EQUIPMENT

Project title:	PREFABRICATED STRUCTURE RELIEF PROGRAMME: SUPPLY AND ERECT TWO CLASSROOM BLOCK AT AMAZI SENIOR SECONDARY SCHOOL
Request for Quotation No:	2022/07/065

The following are lists of major items of relevant equipment that I/we presently own or lease and will have available for this contract or will acquire or hire for this contract if my/our Bid is accepted.

(a) Details of major equipment that is owned by and immediately available for this contract.

Quantity	Description, size, capacity, etc.

Attach additional pages if more space is required.

(b) Details of major equipment that will be hired, or acquired for this contract if my/our Bid is acceptable.

Quantity	Description, size, capacity, etc.

Attach additional pages if more space is required.

Signed _____ Date _____

Name _____ Position _____

Bidder _____

T2.2.10 Compulsory Enterprise Questionnaire

T2.2.10: COMPULSORY ENTERPRISE QUESTIONNAIRE

Project title:	PREFABRICATED STRUCTURE RELIEF PROGRAMME: SUPPLY AND ERECT TWO CLASSROOM BLOCK AT AMAZIZI SENIOR SECONDARY SCHOOL		
Request for Quotation No:	2022/07/065		
The following particulars must be furnished. In the case of a joint venture, separate enterprise questionnaires in respect of each partner must be completed and submitted.			
Section 1: Name of enterprise:			
Section 2: VAT registration number, if any:			
Section 3: CIDB registration number, if any:			
Section 4: CSD number:			
Section 5: Particulars of sole proprietors and partners in partnerships:			
Name*	Identity number*	Personal income tax number*	
<i>*Complete only if sole proprietor or partnership and attach separate page if more than 3 partners</i>			
Section 6: Particulars of companies and close corporations			
Company registration number:			
Close corporation number:			
Tax reference number:			
Section 7: SBD4 issued by National Treasury must be completed for each Bidder and be attached as a Request for Quotation requirement.			
Section 8: SBD6 issued by National Treasury must be completed for each Bidder and be attached as a Request for Quotation requirement.			
The undersigned, who warrants that he / she is duly authorised to do so on behalf of the enterprise:			
<ul style="list-style-type: none"> i) authorizes the employer to verify the Bidders tax clearance status from the South African Revenue Services that it is in order; ii) confirms that the neither the name of the enterprise or the name of any partner, manager, director or other person, who wholly or partly exercises or may exercise, control over the enterprise appears on the Register of Tender Defaulters established in terms of the Prevention and Combating of Corrupt Activities Act of 2004; iii) confirms that no partner, member, director or other person, who wholly or partly exercises, or may exercise control over the enterprise appears, has within the last five years been convicted of fraud or corruption; iv) confirms that I / we are not associated, linked or involved with any other bidding entities submitting Request for Quotation offers and have no other relationship with any of the Bidders or those responsible for compiling the scope of work that could cause or be interpreted as a conflict of interest; and v) confirms that the contents of this questionnaire are within my personal knowledge and are to the best of my belief both true and correct. 			
Signed		Date	
Name		Position	
<i>Enterprise name</i>			

T2.2.11 CIDB Grading Certificate / Proof of Registration

T2.2.11: CIDB GRADING CERTIFICATE/PROOF OF REGISTRATION

Project title:	PREFABRICATED STRUCTURE RELIEF PROGRAMME: SUPPLY AND ERECT TWO CLASSROOM BLOCK AT AMAZIZI SENIOR SECONDARY SCHOOL
Request for Quotation No:	2022/07/065

Bidders are required to submit with their Request for Quotation:

A Certificate of Contractor Registration issued by the Construction Industry Development Board.

**NOTE: PROOF OF CIDB GRADING TO BE ATTACHED TO THIS PAGE BY
BIDDER
IN THE CASE OF A JOINT VENTURE, SEPARATE CERTIFICATES IN
RESPECT OF EACH PARTNER MUST BE SUBMITTED**

T2.2.12 Other certificates, etc.

T2.2.12: OTHER CERTIFICATES, ETC TO BE PROVIDED BY BIDDER

Project title:	PREFABRICATED STRUCTURE RELIEF PROGRAMME: SUPPLY AND ERECT TWO CLASSROOM BLOCK AT AMAZIZI SENIOR SECONDARY SCHOOL
Request for Quotation No:	2022/07/065

Bidders are required to submit with their Request for Quotation:

- Certified copy of CIPC company registration certificate
- Certified copies of ID's of shareholders, members, partners or sole proprietor
- Letter of Good Standing from Bank where Bidder's primary transaction account is
- Certified copy of valid B-BBEE verification certificate or sworn affidavit; a consolidated B-BBEE verification certificate or sworn affidavit to be submitted in the case of a joint venture.
- Letter of Good Standing from Compensation Fund or a licensed insurer as contemplated in the Compensation for Occupational Injuries and Diseases Act 1993
- CSD Registration Summary Report dated not more than thirty (30) calendar days prior to the Request for Quotation closing date
- Original valid SARS tax clearance certificate and pin
- Proof of locality of head office by way of certified copy of municipal account or lease agreement

NOTE: CERTIFICATES, ETC TO BE ATTACHED TO THE RELEVANT PAGE HEREAFTER

Insert certified copy of CIPC certificate

Insert certified copies of ID's

Insert Letter of Good Standing from Bank

**Insert Certified Copy of Valid B-BBEE Verification
Certificate or Sworn Affidavit**

**Insert Letter of Good Standing from Compensation
Fund**

Insert CSD Registration Summary Report

**Insert Original Valid SARS Tax Clearance Certificate
and Pin**

**Insert Certified Copy of
Municipal Account or Lease Agreement**

T2.2.13 Insert Completed Project Reference Forms

PROJECT REFERENCE RETURNABLE 1 OF 3

Project title:	PREFABRICATED STRUCTURE RELIEF PROGRAMME: SUPPLY AND ERECT TWO CLASSROOM BLOCK AT AMAZIZI SENIOR SECONDARY SCHOOL
Request for Quotation No:	2022/07/065

NOTE: This returnable document must be completed by the person who was the principal agent on a construction project of similar value and complexity that was completed successfully by the Bidder.

I, _____ (name and surname) of
_____ (company name) declare

that I was the principal agent on the following building construction project successfully
executed by _____ (name of Bidder):

Project name: _____

Project location: _____

Construction period: _____ Completion date: _____

Contract value: _____

A. Please evaluate the performance of the Bidder on the abovementioned project, on which you were the principal agent, by inserting "Yes" in the relevant box below:

	Very Poor 1	Poor 2	Fair 3	Good 4	Excellent 5
1. Project performance / time management / programming					
2. Quality of workmanship					
3. Resources: Personnel					
4. Resources: Plant					
5. Financial management / payment of subcontractors / cash flow, etc					

B. Would you consider / recommend this Bidder again:

YES	NO

C. Any other comments:

D. My contact details are:

Telephone: _____ Cellphone: _____ Fax: _____

E-mail: _____

Thus signed at _____ on this _____ day of _____ 2022

Signature of principal agent

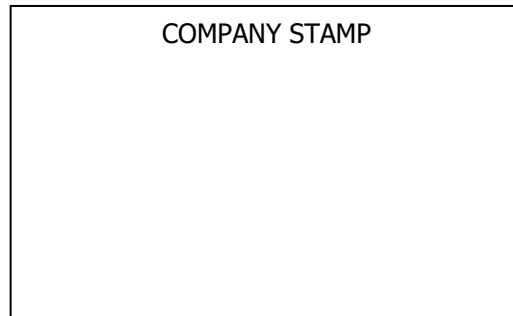

NOTE:

If reference cannot be verified due to the inability to contact the referee or failure on his/her part to respond to a written request to do so, that reference will not score any points.

Name of Bidder

Signature of Bidder

Date

PROJECT REFERENCE RETURNABLE 2 OF 3

Project title:	PREFABRICATED STRUCTURE RELIEF PROGRAMME: SUPPLY AND ERECT TWO CLASSROOM BLOCK AT AMAZIZI SENIOR SECONDARY SCHOOL
Request for Quotation No:	2022/07/065

NOTE: This returnable document must be completed by the person who was the principal agent on a construction project of similar value and complexity that was completed successfully by the Bidder.

I, _____ (name and surname) of
_____ (company name) declare

that I was the principal agent on the following building construction project successfully
executed by _____ (name of Bidder):

Project name: _____

Project location: _____

Construction period: _____ Completion date: _____

Contract value: _____

A. Please evaluate the performance of the Bidder on the abovementioned project, on which you were the principal agent, by inserting "Yes" in the relevant box below:

	Very Poor 1	Poor 2	Fair 3	Good 4	Excellent 5
1. Project performance / time management / programming					
2. Quality of workmanship					
3. Resources: Personnel					
4. Resources: Plant					
5. Financial management / payment of subcontractors / cash flow, etc					

B. Would you consider / recommend this Bidder again:

YES	NO

C. Any other comments:

D. My contact details are:

Telephone: _____ Cellphone: _____ Fax: _____

E-mail: _____

Thus signed at _____ on this _____ day of _____ 2022

Signature of principal agent

COMPANY STAMP

NOTE:

If reference cannot be verified due to the inability to contact the referee or failure on his/her part to respond to a written request to do so, that reference will not score any points.

Name of Bidder

Signature of Bidder

Date

PROJECT REFERENCE RETURNABLE 3 OF 3

Project title:	PREFABRICATED STRUCTURE RELIEF PROGRAMME: SUPPLY AND ERECT TWO CLASSROOM BLOCK AT AMAZIZI SENIOR SECONDARY SCHOOL
Request for Quotation No:	2022/07/065

NOTE: This returnable document must be completed by the person who was the principal agent on an construction project of similar value and complexity that was completed successfully by the Bidder.

I, _____ (name and surname) of
 _____ (company name) declare

that I was the principal agent on the following building construction project successfully
 executed by _____ (name of Bidder):

Project name: _____

Project location: _____

Construction period: _____ Completion date: _____

Contract value: _____

A. Please evaluate the performance of the Bidder on the abovementioned project, on which you were the principal agent, by inserting "Yes" in the relevant box below:

	Very Poor 1	Poor 2	Fair 3	Good 4	Excellent 5
1. Project performance / time management / programming					
2. Quality of workmanship					
3. Resources: Personnel					
4. Resources: Plant					
5. Financial management / payment of subcontractors / cash flow, etc					

B. Would you consider / recommend this Bidder again:

YES	NO

C. Any other comments:

D. My contact details are:

Telephone: _____ Cellphone: _____ Fax: _____

E-mail: _____

Thus signed at _____ on this _____ day of _____ 2022

Signature of principal agent



NOTE:

If reference cannot be verified due to the inability to contact the referee or failure on his/her part to respond to a written request to do so, that reference will not score any points.

Name of Bidder

Signature of Bidder

Date

THE CONTRACT

Part 4: Scope of Work

C3.1 Scope of work

C3.1: SCOPE OF WORKS – JBCC 2000 PRINCIPAL BUILDING AGREEMENT (Edition 4.1 of March 2005)

Project title:	PREFABRICATED STRUCTURE RELIEF PROGRAMME: SUPPLY AND ERECT TWO CLASSROOM BLOCK AT AMAZIZI SENIOR SECONDARY SCHOOL
Bid No:	2022/07/065

C3. Scope of Works

1. GENERAL

a) EXTENT OF THE WORKS

The work comprises the construction of two classroom block in the prefabricated structure relief programme. Paving, stormwater control and connecting to the existing electrical supply.

b) ORDER OF THE WORKS

Commencement of the works after handover, daily progress and completion of the works is critical to the success of the programme and will thus be closely and strictly monitored. Decisive action will be taken against any potential risks that could lead to time over run on the contract period. The bidder is to take specific notice of this, most especially to the penalty clause.

c) BUILDING OCCUPIED

Yes

d) ACCESS – Gravel Road

C3.2 Health and Safety Specification

 Province of the EASTERN CAPE EDUCATION	PROJECT SPECIFIC HEALTH AND SAFETY SPECIFICATION (SMALL PROJECTS)	ECDoE	T035
		Rev	00
		Date	31/07/2020
		Page	1 of 31

SITE SPECIFIC OCCUPATIONAL HEALTH AND SAFETY SPECIFICATION

Prepared by

Dr Claire Deacon
 PrCHSA
 SACPCMP CHSA010/2013

FOR

PREFABRICATED STRUCTURE RELIEF PROGRAMME TWO CLASSROOM BLOCK – DESIGN SUPPLY AND ERECT AMAZI SENIOR SECONDARY SCHOOL

RFQ NO: 2022/07/065

	PROJECT SPECIFIC HEALTH AND SAFETY SPECIFICATION (SMALL PROJECTS)	ECDoE	T035
		Rev	00
		Date	31/07/2020
		Page	2 of 31

Table of Contents

Site Details:.....	4
REFERENCES, INCLUDING COVID-19	4
1. LIST OF ABBREVIATIONS	4
2. Purpose of the Site Specific Health and Safety Specification (SSHSS)	5
2.1 Project description/detailed scope of work as it applies to the project (Details as per the scope of work) 6	
2.2 Programme Description	6
3. Implementation of the Site Specific Occupational Health and Safety Specifications (SSHSS)	7
4. GENERAL REQUIREMENTS	8
4.1 Summary of Risks identified during Design	8
4.2 Specified Hazardous Chemical Substances	9
5. OCCUPATIONAL HEALTH & SAFETY MANAGEMENT	9
5.1 Structure and Organization of H&S Responsibilities.....	9
5.1.1 Notification of Commencement of Construction Work.....	9
6. HEALTH AND SAFETY PLAN FRAMEWORK	10
6.1 Appointment of Competent Site Personnel.....	10
6.1.2 Construction Health and Safety Officer	11
7. GENERAL RISK MANAGEMENT	12
8. Training.....	13
8.1 Site Induction and other training.....	13
8.2 Noise Risks	14
9. Emergency Procedures.....	14
9.1 Fire, First Aiders and First Aid Equipment.....	15
9.2 Incident Management and Compensation Claims	15
10. Personal Protective Equipment (PPE) and Clothing.....	15
11. Occupational Health and Safety Signage	16
12. Induction of Employees and Visitors, General H&S Training.....	16
13. Management of Plant and Equipment	16
14. Excavations (if applicable)	16
15. Working at heights (if applicable).....	17
16. Cranes and lifting equipment (if applicable).....	17
17. Temporary Works (Scaffolding, support work, formwork) (if applicable)	18
18. Auditing	18
19. Communication and Meetings on Site	18
20. Care of Workers on Site (Welfare).....	19



ECDoE	T035
Rev	00
Date	31/07/2020
Page	3 of 31

21.	HEALTH AND SAFETY FILE	19
22.	NON-CONFORMANCES	20
23.	Failure to Comply with Provisions	20
24.	Public safety.....	21
	ANNEXURE A	22
	PrCHSA AUDIT SHEET	22
	ANNEXURE B	26
	CLOSE OUT REQUIREMENTS	26
	ANNEXURE C	27
	NON-CONFORMANCES	27

Project Details

Date of compilation:	Revision number: 00
Value of project:	Commencement date:
	Contract period:

	PROJECT SPECIFIC HEALTH AND SAFETY SPECIFICATION (SMALL PROJECTS)	ECDoE	T035
		Rev	00
		Date	31/07/2020
		Page	4 of 31

Occupational Health and Safety Agent:

<i>Professional responsibilities</i>	<i>Company</i>	<i>Contact person</i>	<i>Telephone</i>	<i>Fax</i>	<i>email</i>
Architects	See C1.2 Contract Data				
Civil Engineers					
Structural Engineers					
Electrical Engineers					
HVAC Engineers & Fire Consultants					
Quantity Surveyors					

Site Details:

Locality of the works:

REFERENCES, INCLUDING COVID-19

- The National Disaster Management Act (NDMA), Regulations issued in terms of Section 27(2) of the Act;
- Covid-19 Occupational Health and Safety Measures in Workplaces Covid-19 (C19 OHS), 2020 Reg No 43257 No 479;
- Occupational Health and Safety Act (OHSA) No. 85 of 1993 and Regulations (as amended);
- Compensation for Injury and Occupational Diseases Act (COIDA) No. 100 of 1993 (as amended);
- South African Council for the Project and Construction Management Professions (SACPCMP) 2013: Scope of services for the CHS Agent, Manager and Officer;
- Any other internal standards and specifications developed by the Client as they affect the operations, and
- The amended Baseline Risk assessment
- South African Roads Traffic Safety Manual (SARTSM) Chapter 2, Volume 13 of 1999
- Road Traffic Safety Act No. 93 of 1996 (as amended)
- Construction Specifications & Standards 6.0 for Southern Africa. Hans Wegelin 6th Edition 2010
- SANS Code 10400
- SABS 1200

1. LIST OF ABBREVIATIONS

AIA	Approved Inspection Authority
BoQ	Bill of Quantities
CC	Compensation Commissioner
CR	Construction Regulations
CHSO	Construction Health and Safety Officer
DMR	Driven Machinery Regulations

	PROJECT SPECIFIC HEALTH AND SAFETY SPECIFICATION (SMALL PROJECTS)	ECDoE	T035
		Rev	00
		Date	31/07/2020
		Page	5 of 31

DEL	Department of Employment and Labour
FEMA	Federated Employers Mutual Association
GAR	General Administration Regulations
GSR	General Safety Regulations
HCSR	Hazardous Chemical Substances Regulations
HIRA	Hazard Identification Risk Assessment
H&S	Health and Safety
ER	Engineer's Representative
LI	Labour Intensive
DMA	Disaster Management Act
OH	Occupational Health
OHSA	Occupational Health and Safety Act No. 85 of 1993 (as amended)
SSHSS	Site Specific Health and Safety Specification
PC	Principal Contractor
PPE	Personal Protective Equipment
PrCHSA	Professional Health and Safety Agent
SANS	South African National Standards (Authority)
SACPCMP	South African Council for Project and Construction Management Professions
SDS	Safety Data Sheet
SMME	Small, Micro, Medium Enterprise
SWP	Safe Work Procedure

Each year fatalities, serious injuries and poor attitudes of Contractors mar the reputation of the Construction Industry. The CLIENT has a responsibility to limit its risk by ensuring a zero tolerance and better practice approach to Contractors and those affiliated to a particular project. Thus, a high premium is placed on the health and safety (H&S) of the Client and stakeholders, which include its employees, professional service providers, public and its physical assets.

The responsibilities that the Client and relevant stakeholders have toward its employees are captured in, but not limited to this document. The responsibilities stem from both moral, civil and a variety of legal obligations. The Principal Contractor is to take due cognisance of the above statement.

Where there is an appointed PrCHSA on its behalf, shall provide a site specific Health & Safety Specification (SSHSS) for the project and provide the Principal Contractor/s (PC) making a bid or appointed to perform construction work for the project, or parts thereof.

By drawing up this SSHSS, the Client has endeavoured to address the most critical aspects relating to H&S issues in order to assist the contractor in adequately providing for the health and safety of employees on site.

Should the Client not have addressed all H&S aspects pertaining to the work that is tendered for, the contractor needs to include it in the SSHSP and inform the Client of such issues when submitting the tender, or as soon as identified.

Notwithstanding the above, cognisance needs to be taken of the current Disaster Management Plan, and all the requirements of the current levels of lockdown, standards, guidelines and information published from time to time.

2. Purpose of the Site Specific Health and Safety Specification (SSHSS)

	PROJECT SPECIFIC HEALTH AND SAFETY SPECIFICATION (SMALL PROJECTS)	ECDoE	T035
		Rev	00
		Date	31/07/2020
		Page	6 of 31

The SSHSS is a performance specification to ensure that the Client and any bodies that enter into formal agreements with the Client, Agents, Professional Designers (Engineers, Quantity Surveyors and Architects), Principal Contractors and Contractors achieve an acceptable level of OHS performance.

No advice, approval of any document required by the SSHSS, such as hazard identification and risk assessments, or any other form of communication from the Client shall be construed as acceptance by the Client of any obligation that absolves the Principal Contractor from achieving the required level of performance and compliance with legal requirements. Furthermore, there is no acceptance of liability by the Client, which may result from the Principal Contractor failing to comply with the SSHSS, i.e. the Principal Contractor remains responsible for achieving the required performance levels.

A Mandatory Agreement in terms of Section 37.2 of the OHSA will be signed between parties prior to any works commencing. If the NEC contract is used a copy of the signed contract shall form part of the H&S file submission.

The SSHSS highlights the aspects to be implemented over and above the minimum requirements of current legislation. Requirements may be changed should new risks or issues are identified that could not have been foreseen during the design phase of the project, or during the construction phase. Any new legislation or standards (legislated or determined by the Client) that are promulgated or accepted during the contract will automatically be applied.

Environmental management shall receive due attention as per the requirements of the Environmental Control Officer (ECO), but will be managed by the ECO directly if applicable to the project.

2.1 Project description/detailed scope of work as it applies to the project (Details as per the scope of work)

The Scope of work as identified by the Stakeholders is as follows:

- Preliminary and General
- Breaking
- Painting
- Carpentry
- Brickwork
- Roof Work
- Asbestos Work
- Supply and install prefabricated structures

The works shall be done in accordance with the applicable SANS 1200 specifications, Municipal By-laws and Regulations, variations and additions to the standardized specifications applicable to this contract and the technical specifications of the Client for work that falls outside of the standardized specifications.

2.2 Programme Description

Clarification Meeting	<i>TBA</i>
Time allowed for preparation of H&S plan/file after tender award	
Approval date of SSHSP	<i>Within 1 week after submission but subject to content as per this requirement, for more than one review.</i>
Induction dates	<i>To be advised after Approvals of H&S Plan/file</i>
Estimated Commencement date of work on site	<i>Subject to approval of H&S Plan.</i>

	PROJECT SPECIFIC HEALTH AND SAFETY SPECIFICATION (SMALL PROJECTS)	ECDoE	T035
		Rev	00
		Date	31/07/2020
		Page	7 of 31

Estimated Project completion date or project duration	<i>Dependant on site establishment and site hand over</i>
Project term	

3. Implementation of the Site Specific Occupational Health and Safety Specifications (SSHSS)

The site specific H&S specification (SSHSS) forms an integral part of the Contract, and PCs are required to make it an integral part of their Contracts with Contractors and Suppliers. A SSHSS will be available for each level of Contract and Contractor and must be complied with.

This specification must be read in conjunction with the OHSA, Regulations (as amended) and any other standards relating to work being done and ensure compliance thereto. The information relative to the scope of the project, the works etc. are detailed in the tender, are to be considered when developing the SSHSP and associated documentation. The summary of risks is included in Section 2 of the SSHSS.

The OHSA S.37.2 Mandatory Agreement must be fully completed by the PC, supplied by the Client. These documents shall be deemed to form part of the returnable Contract Documents.

No work may commence without written approval of the SSHSP by the H&S Agent, or the responsible person of the Client.

Should there be design changes, or change in the scope of works, an amended SSHSS may be issued. Where amended SSHSSs are issued, the PC will be required to ensure a resubmission of an amended SSHSP for approval. Further to this, the PC must ensure that similar information must be provided as it applies to the works to all their Contractors, within 5 working days following notification thereof. Such design changes.

The PrCHSA will visit the project at least bi-monthly to ensure compliance and limit risk. All activities on the site and all appropriate documentation will be monitored and reported on to the Client and the Designer.

Non-conformances will be issued, and penalties or work stoppage will be issued where appropriate. Communication between the PrCHSA and the PC will be through the Designer (or Client's responsible person) as determined at the commencement of the project.

3.1 Requirements at Start Up

The submission will effectively reduce the time and issues prior to commencement of the project. The site may need to be deep cleaned if previously occupied as per the Department of Labour (DEL) requirements for safe occupation by the PC. Details of the COVID-19 policy and risk assessments will be required to be done as part of the

A site specific H&S Plan (SSHSP) in response to this SSHSS will be subject to approval by the PrCHSA within the stipulated time period as noted in the tender. This must include all supporting documentation as required to verify the H&S system:

- A declaration to the effect that the PC has the competence and necessary resources to carry out the work safely in compliance with the Occupational Health and Safety Act and its Regulations;
- A valid Letter of Good Standing;
- Detailed technical method statements along with, and aligned with the project programme for review by the Principal Agent, Designer and appropriate risk assessments and safe work procedures for approval by the PrCHSA or Client;
- Site establishment including:

	PROJECT SPECIFIC HEALTH AND SAFETY SPECIFICATION (SMALL PROJECTS)	ECDoE	T035
		Rev	00
		Date	31/07/2020
		Page	8 of 31

- A procedure must be drafted relative to protection/ prevention of injury to persons other than PC employees, during undertaking of such construction activity.
- Exposure of services, power, telecommunication etc.;
- Arrangements for hoarding, traffic accommodation if applicable:
- Excavating for services;
- An emergency plan indicating how and where emergencies will be handled, and
- Working at heights (if applicable).

Further method statements are to be submitted prior to, and during the project where changes or new work is required, and the approval of the Principal Agent/Client is required before work on that aspect or activity can commence. The construction CHSO (CHSO) is to be included in production planning sessions/meetings to ensure that the appropriate risk assessments, safe work procedures and communication required are available and completed timeously.

Penalties will be applied should this not be adhered to and deemed a serious offence.

4. GENERAL REQUIREMENTS

4.1 Summary of Risks identified during Design

The intention of the summary of findings from the design risk assessment is to highlight the residual risks identified during the design phase. The full design risk assessment can be found in the tender document.

The summary of risks provided is to point the contractor towards some risks he may not be aware of during tendering stage and while developing his formal risk assessments for the project.

The design risks and the management thereof should be included in the PC risk assessments. Where there are other Contractors appointed to do work, the PC is to ensure that Contractors include such information in their risk assessments.

The summary is to be developed following the completion of the Design risk assessment, and to include the residual risks as they apply to the project.

PHASES OF THE PROJECT	RESIDUAL RISKS IDENTIFIED TO BE MANAGED (as applicable)
Site Establishment	Bringing in containers, fitting with electricity, phone and fax, toilet hire. Hoarding, security and access to be managed and in place.
Site Clearance	Traffic accommodation, movement of heavy construction vehicles, use hand tools, chainsaws, use of local labour and contractors.
Earthworks	Open excavations, use of plant and machinery, use of lifting equipment for laying storm water concrete pipes, electrical hand tools plant and equipment during paving. Noise monitoring.
Ancillary Roadworks	Use of chemicals, excavation and use of hand tools.
Housekeeping, stacking and storage	The area is adequate to ensure housekeeping and stacking and storage principles are followed. However, the children need to be kept well away from all work areas including the site camp, and notices to be clear in warning of dangerous construction activities. Care and increased attention to ensure all materials and vehicles are carefully managed and designated routes are

	PROJECT SPECIFIC HEALTH AND SAFETY SPECIFICATION (SMALL PROJECTS)	ECDoE	T035
		Rev	00
		Date	31/07/2020
		Page	9 of 31

	used.
General	Use of local labour, and contractors, CLO to do regular information sessions. High winds and inclement weather require monitoring for all working at heights
Painting	Hand mixing may occur, 50kg paint drums are an ergonomic risk from handling. Potential eye, skin and respiratory irritant from paint fumes exposure, chromates.

4.2 Specified Hazardous Chemical Substances

The following lists of products or substances are those which have been identified as likely to be used on the project. This list is not inclusive and other products may be considered. Where the PC is likely to supply the product as the product has not been specified, safety data sheets (SDSs) need to be considered prior to all selections.

PRODUCTS/SUBSTANCES/RISKS	POTENTIAL HEALTH OR OTHER RISKS
Cement	Hand mixing may occur, 50kg bags are an ergonomic risk from handling. Potential eye, skin and respiratory irritant from dust exposure, chromates.
Cement/Silica dust	Caused by cutting, grinding, sanding of any concrete/granite/tiled surface/masonry.
Wood dusts	Caused by cutting, sanding, drilling wooden products treated Viz fencing poles.
Mineral turpentine	Applying paint and cleaning of paint brushes. Potential eye, nose, skin and respiratory irritant.
Paint	Splashes into eyes, onto skin causing irritation.
Cleaning materials	Use of disinfectants and sanitizers

5. OCCUPATIONAL HEALTH & SAFETY MANAGEMENT

5.1 Structure and Organization of H&S Responsibilities

An organogram will be available to identify key appointments and responsibilities on site and be kept up to date throughout the project.

5.1.1 Notification of Commencement of Construction Work

The PC shall notify the Provincial Director of the Department of Employment and Labour (DEL) in writing, in the form of the Annexure in the CRs. This shall occur within 7 days of the award of the contract. Proof of submission and/or receipt must be provided and kept in the H&S file.

Where changes to the conditions given in the submission are required (i.e. Contractors, completion dates, increase in workers), a revised Annexure A must be submitted to the DEL. The completion date is to include the defect and liability period. A copy of the notification form and any further submissions/correspondence must be kept in the H&S file.

	PROJECT SPECIFIC HEALTH AND SAFETY SPECIFICATION (SMALL PROJECTS)	ECDoE	T035
		Rev	00
		Date	31/07/2020
		Page	10 of 31

6. HEALTH AND SAFETY PLAN FRAMEWORK

The H&S aspects related to the project outlined in the previous sections are to be taken into account when drawing up the H&S Plan. The PC is required to demonstrate competence by providing an H&S system that will address the requirements of the project.

The current legislative requirements, SABS codes, SANS 10400 and any other standards that may guide practice are to be taken into consideration. The following aspects must be addressed in the SSHSP, as they have been identified in section 2, as playing a role in reducing the overall risk of a particular activity, or section of the project. The PrCHSA may from time to time request additions or systems as they relate to the works or legislative requirements at the time.

The PC is to prepare a site layout drawing to indicate at least the following to submit with the H&S plan:

- The positions of site offices of all Contractors, toilets, drinking water and worker rest areas;
- Indicate the positions of emergency planning and equipment and first aiders;
- Protection of plant and public, indicate parking, designated vehicular routes and access to site;
- Storage areas (materials and equipment, waste etc.), and
- Storage of materials and waste;

Such layouts are to be updated regularly throughout the project.

A Covid-19 Compliance Manager or co-ordinator is to be appointed to co-ordinate any matters relating to ensuring compliance.

Cognisance is to be given to those permanent employees who are over 60 years of age, and younger workers who have underlying chronic health issues such as high blood pressure, diabetes, TB, HIV and AIDS etc. Specialised workers who are indispensable will need to be declared fit for work by an occupational health service provider.

Key appointments and succession planning is to be available to ensure those who are playing key roles are able to cover the project at all times.

The project Organogram is to be updated accordingly and signed and dated at each update.

6.1 Appointment of Competent Site Personnel

The CEO (OHSA S16.1 or 16.2) of the PC will take overall responsibility for the appointment of competent site staff for the duration of the project. Should the CEO not be personally involved in the project, the H&S responsibilities are to be delegated to the Site Agent (OHSA 16.2). Knowledge and training in H&S are required and certificates indicating H&S training as well as experience to be included in CVs.

All other legal appointments are to be made with relevance to the type of work required and kept current with the project programme. The construction team is to ensure the appointed CHSO is kept up to date with all planned activities, to ensure all H&S requirements are met.

All construction/technical method statements are to be generated by senior site personnel, and the appropriate risk assessments developed therefrom in conjunction with the CHSO.

The SSHSP shall include the following, but is not limited to the following key appointments:

	PROJECT SPECIFIC HEALTH AND SAFETY SPECIFICATION (SMALL PROJECTS)	ECDoE	T035
		Rev	00
		Date	31/07/2020
		Page	11 of 31

6.1.1 Construction Supervision

Competent supervisors will be appointed to manage part or all of the works and have training and/or experience in the area of responsibility, regarding CR 8.1, 8.2 and 8.8. All site supervisors must show evidence of appropriate training in H&S, and an understanding or training in areas of responsibility (i.e. risk assessments, method statements etc.).

Curriculum Vitae (CVs) are to be submitted for approval by the Principal Agent, and/or Client. The Supervisor will be held responsible for the safety of working teams and subordinates, housekeeping and stacking and storage of materials.

6.1.2 Construction Health and Safety Officer

The PC shall employ at least one competent, CHSO for the duration of the contract. The CHSO's CV is to be submitted for approval by the PrCHSA or the Client, at time of tender

The PC is to ensure adequate resources are provided in order to undertake all responsibilities (i.e. mobile phone, computer and internet access, etc.).

Qualifications shall include at least Grade 12, SAMTRAC/NEBOSH/Diploma in H&S qualifications or similar, with exposure to civil engineering and similar road construction, with at least 5 years experience, given the level of project complexity preferably in an OHS capacity. He should also have undergone training in the Act and Regulations. In the case of a contract where contractors are employed, the CHSO must have a competence to evaluate the Contractors Health and Safety plans and be registered with the SACPCMP as a CHSO.

This person may not hold any other position on the site staff. The site supervisor may not act as the CHSO. The CHSO appointed for the project will be held responsible for all H&S on the project.

- Senior site staff and supervision, Contractors are to follow systems, instructions etc. given by the CHSO at all times;
- No new workers or Contractors may commence work without approval or following the SSHSP as submitted;
- No inductions of any Contractors' staff until the H&S documentation is approved by the CHSO, and
- The CHSO may not be removed or replaced without the approval of the H&S Agent, nor may the site be left unattended for more than 1 day without adequate, competent cover.

A monthly report of all H&S activities and incidents is required by the end of the first week of each month, or at a date agreed to by the H&S Agent/Client and the CHSO. An example of the monthly report is attached as an Annexure D.

The CHSO will be responsible for collating the H&S documentation at the close out of the project in electronic format, properly labeled and filed. A list of the typical aspects that should be provided is available as Annexure B to this document. The PC is to ensure that all Contractors documentation follows the same requirements and closed out. H&S documentation must be completed and be available with the close out of the main contract, or as determined at the time.

Failure to do so will be considered a serious offence and penalties applied. Failure could also result in retentions or project certification not being issued to the PC.

6.1.3 Traffic Safety

The CHSO will be responsible for ensuring that daily traffic management is adequately managed.

	PROJECT SPECIFIC HEALTH AND SAFETY SPECIFICATION (SMALL PROJECTS)	ECDoE	T035
		Rev	00
		Date	31/07/2020
		Page	12 of 31

No worker may be transported in, or on the rear of construction vehicles (bakkies included), or with plant and materials to, on, or from site. The number of passengers in any vehicle is limited to what is stated on the license disc. Vehicles used to transport workers to, from, or on site, shall have secure seats and be covered. No canopies may be used.

While this is difficult to control by the PC, induction training needs to include such information so workers can protect themselves. An on-site transportation policy needs to be available for how such transportation will be made safe and limit any opportunity for cross infection. Disinfection of vehicles needs to be determined where possible, and sanitizers provided prior to boarding and recommended during transit.

Each worker is to be encouraged to wear a cloth mask while travelling, and this needs to be enforced if using company transport.

Penalties will be issued for non-compliances noted.

6.1.4 Health and Safety Representatives and H&S meetings (if applicable)

H&S Representatives representing workers and Contractors are to be appointed following the start up of the project, irrespective of the number of workers on site. The appointed H&S Representatives are to be actively involved with H&S and will assist the CHSO and site management in meeting legislative duties.

All internal and external PrCHSA audits are to be discussed, as well as all H&S related issues at all internal production or progress meetings.

Issues relating to COVID-19 will be included in the meetings and involvement with all related issues will be noted.

Failure to do so will be deemed to be a moderate offence.

6.1.5 Appointment of Competent Contractors and Suppliers, short term works (if applicable)

The PC is to ensure compliance with the Clients minimum standards and all legislative requirements. The same H&S standards required of the PC are to be applied to all Contractors. An index of all Contractors and Suppliers is to be on file and kept updated at all times. The PC is to ensure there is sufficient funding for H&S compliance by each Contractor.

The following minimum aspects are applicable to any Contractor appointed:

- The CHSO is to ensure a Contractors appointment and approval of H&S documentation at least seven (7) working days prior to commencing work;
- No Contractor may work under the PCs Compensation registration number. If required, the PC may assist SMMEs with their registration with the Compensation Commissioner (CC). However, such Contractors will not be able to commence work until proof of registration or Letter of Good Standing has been received, and
- No work may commence without Mandatary agreements between parties in place.

Suppliers or short-term works (surveying, repairs, servicing, deliveries etc.) also require H&S Management. Cognisance is to be taken of the level of risk involved and the CHSO is to ensure the level of H&S documentation is appropriate and appropriately managed.

Failure to provide written approval of H&S documentation will be considered a serious offense, and could result in aspects of, or all the activities being stopped, and penalties implemented.

7. GENERAL RISK MANAGEMENT

	PROJECT SPECIFIC HEALTH AND SAFETY SPECIFICATION (SMALL PROJECTS)	ECDoE	T035
		Rev	00
		Date	31/07/2020
		Page	13 of 31

7.1 Health Risks and Medical Surveillance

The appropriate SDSs are to be obtained for all products and used to develop the H&S documentation as they relate to the works. Many of the processes are labour intensive and ergonomic risks are to be noted. All workers (including Contractors) are to be included in the medical surveillance programme.

Workers will be exposed to noise, dust, and physical risks from extended periods of work of a repetitive nature, materials specified and the general nature of the works.

All permanent workers (including those of Contractors) are required to be in possession of a medical certificate of fitness prior to arrival on site that must be less than 12 months old. An exit medical will be required where the project exceeds 6 months in duration. Arrangements for keeping medical records for the required time are to be noted. A procedure for managing the medical records which require safekeeping for prescribed periods are to be addressed, specifically for the asbestos exposed workers.

Given the COVID-19 pandemic and lasting effects, workers who have co-morbidities (chronic medical conditions such as high blood pressure, diabetes, cancer, HIV and AIDS etc.) need to be cleared to work prior to being allowed on site.

Given the potential health risks the following aspects are to be included in each medical surveillance intervention:

- Full medical, surgical and occupational history;
- Full physical examination of all systems, and
- Referral if required for the management of identified health issues that may affect the worker.

Specific testing for existing conditions and limitations relative to exposure could include, but are not limited to:

- Audiometry (hearing tests);
- Spirometry (lung function tests) are not to be done until deemed safe to do so, and
- Any other tests identified as relevant from chemical or specifically identified risks of exposure

Workers will be required to complete COVID-19 questionnaires prior to returning to site. Any worker with any symptoms is not to return to work or notify the PC of same. No worker may be discriminated against or victimized for being ill.

Failure to do so will be considered a serious offence.

8. Training

Training of site personnel in H&S in the revised areas of work is required, mainly through induction between the Client and specific groups of employees. All programmes to have an element of information and detail relating to COVID-19 as it applies to the project, and in some cases by the Client. The CHSO is to determine training requirements and to report on needs or completed training in their reports and audits.

Records of all training, and acknowledgement of such training by attendees must be kept. Comprehensive records of all employees under the PCs control attending induction or any other training throughout the project shall be included. Amendments to statutes, the SSHSS, PSHSP, policies, procedures, method statements etc. shall require that all those affected shall undergo the relevant re-training.

8.1 Site Induction and other training

The PCs shall ensure that all employees, and contractors have undergone the induction programme for visitors or contractors, or any other that is deemed necessary, including training by the Client as it relates to COVID-19.

	PROJECT SPECIFIC HEALTH AND SAFETY SPECIFICATION (SMALL PROJECTS)	ECDoE	T035
		Rev	00
		Date	31/07/2020
		Page	14 of 31

Where possible no classroom activities will be allowed unless the social distancing aspect has been addressed, a minimum of 1.5m between persons.

Appropriate time must be set-aside for training (induction and other) for all employees. No person will be able to commence work or visit the site where the induction has not been done.

All employees and visitors on site from either the Client or the PC shall carry the proof of induction training in form of an induction card. Client Induction is valid for a year from the date it was conducted and thereafter refresher induction shall be re-scheduled at least one month before the induction period expires.

Both parties shall keep a database of all records pertaining to induction and will inform Contractors of pending expiry though the overall responsibility of maintaining current induction cards still lies with the principal contractor. All induction cards issued must be returned on completion of the project to the Issuer.

Toolbox talks to be conducted outdoors when possible in order for persons to maintain social distancing. Where inclement weather does not allow for this, toolbox talks to be conducted with smaller groupings of workers in a sheltered area large enough to maintain social distancing.

8.2 Noise Risks

All plant from plant hire companies (suppliers) or that of the PC is to come to site with the appropriate testing completed and be compliant with the Noise Induced Hearing Loss Regulations. Plant identified that has not been tested and marked for noise emissions will result in having to be tested or removed from site. Failure to do so within a reasonable time period will result in such plant being removed from site.

Suitable SANS approved hearing protective equipment shall be issued and worn where noise levels are identified as equal to or greater than 85 dB.

8.3 Asbestos Work

Only a registered asbestos contractor may do work which entails asbestos material. An Approved Inspection Authority must be consulted and Asbestos regulations complied to.

Failure to do so will be considered a serious offence.

9. Emergency Procedures

A simple emergency plan and procedure that is appropriate to the risks is required prior to commencement on site. It is advised that the system should be simple and easy for any worker to follow. The plan may be adapted should new information or risks are identified.

Social distancing of 1.5m when there is an evacuation is required. Measures to protect workers who are having to treat a potentially COVID-19 positive employee needs to be addressed.

The procedure shall detail the response plan in relation to the works, and include at least (but are not limited to) the following key elements:

Appointment of a competent emergency response co-ordinator

- Fire, public injury, asbestos;
- Falls from heights;
- Serious injury to workers (medical or work-related), and

	PROJECT SPECIFIC HEALTH AND SAFETY SPECIFICATION (SMALL PROJECTS)	ECDoE	T035
		Rev	00
		Date	31/07/2020
		Page	15 of 31

- Any other major risks identified during risk assessments

The emergency plan is to ensure the inclusion of local service providers. Such arrangements should be made with these persons prior to the commencement of the project. The general principals of emergency management are to be applied as it applies to the hierarchy of control and management.

9.1 Fire, First Aiders and First Aid Equipment

At least 1 first aider will be trained to level 1. First aiders shall be available and accessible on site at all times and be able to work as a team when responding to any emergency on the project. The number of First aiders will be determined by the complexity and exposed risks of the project, not numbers of workers. COVID-19 preventative measures such as N19 or FFPT2 masks, surgical gloves and disinfectants will be needed to be supplied.

Contractors are expected to ensure compliance and provide/manage their own first aiders and equipment. Appropriately stocked first aid kits are to be available at all times and to assure continual availability and access on site.

Fire extinguishers will be appropriate for the risk and in sufficient numbers to deal with the type of fires that could occur. All mobile plant is to have fire extinguishers. Hot work permits are required for any such activities.

Failure to comply with emergency provisions will be considered a serious offence, and the operation or project may be stopped if deemed inadequate for the work at the time of assessment or site inspection.

9.2 Incident Management and Compensation Claims

All incidents and accidents are to be investigated. All serious incidents involving any form of disabling injury or fatality are to be reported to the Principal Agent/Client /PrCHSA immediately. This shall be confirmed in writing following the incident. Full details are to be included in each site meeting or when the Client visits site. A summary of incidents is to be included in the monthly report.

Exposures to COVID-19 cases at entrances or on site are to be treated as incidents, and potentially as compensation cases if deemed work exposure. An Occupational Health Practitioner will be required to follow through with the case and the NSCDs and DEL will also need to be notified,

Failure to comply with emergency provisions will be considered a serious offence, and the operation or project may be stopped if deemed inadequate for the work at the time of assessment or site inspection.

10. Personal Protective Equipment (PPE) and Clothing

The PC is to provide a procedure as an addendum to indicate how PPE is managed within the Company. The wearing of the identified SANS approved PPE at all times is non-negotiable and is to be linked to the risk assessments. The PC shall ensure that all workers (Including Contractors) are issued with and shall wear:

- Hard hats;
- Protective footwear;
- Eye protection;
- Hearing protection;
- Reflective jackets (no bibs);
- At least 3 cloth masks (for general wear);
- Respiratory protection (minimum of FFP2) or as deemed required by the AIA, and
- Any other necessary PPE identified from SDSs and/or risk assessments.

Adequate quantities of PPE shall be available. This shall include necessary PPE for visitors. The procedures for managing PPE are to be in a formal procedure submitted with the SSHSP for approval.

	PROJECT SPECIFIC HEALTH AND SAFETY SPECIFICATION (SMALL PROJECTS)	ECDoE	T035
		Rev	00
		Date	31/07/2020
		Page	16 of 31

Any person (including Client, Agents, etc.) found on site without the necessary PPE will be removed from site until the PPE is supplied and worn.

Failure to comply will result in penalties being applied.

11. Occupational Health and Safety Signage

On-site H&S signage is required that must include COVID-19 information as well as standard H&S information. Signage shall be posted up at fixed or temporary working areas, or other potential risk areas/operations. These signs shall be in accordance with the requirements of the General Safety Regulations or SANS requirements as amended. Signage is to be noted on the site drawings indicating where fixed/temporary signage is required and appropriate to the risks identified in risk assessments.

Signs shall be posted at areas of work on site indicating that a construction site is being entered and that persons should take note of H&S requirements.

Failure to comply will result in penalties being applied.

12. Induction of Employees and Visitors, General H&S Training

A simple, formal induction programme is to be submitted as an addendum for approval with the H&S plan. Inductions must be carried out for all workers and visitors (including Client, Designers) to the site.

Daily, pre-task training is required to ensure workers are familiar with the risks and H&S measures of the work or tasks to be done. Records to be kept in the H&S file.

Any person found on site without proof of induction will be removed from site until the proof is supplied and, and a **penalty issued per non-compliance.**

13. Management of Plant and Equipment

The CHSO will ensure control of all plant and equipment, including daily monitoring, prior to commencing work. Full lists of hired and own plant are to be available at the H&S Agent's/Client audit. All daily inspection records are to be kept in the H&S file, or Contractors where plant and equipment is brought onto site. Registers are not to be more than 1 week behind.

Only competent, fit plant operators are to be used. Medical certificates of fitness are required for all operators.

Any plant or slings used to lift plant or material require annual load testing by an AIA, and all certificates must have the testers LMI/E number. Operators are to be adequately trained and certified to operate mobile cranes or crane trucks. Certificates and registers are to be placed in the H&S file.

All plant and equipment will be cleaned at least daily or before issue with an appropriate cleaning material to limit the spread of COVID-19.

Failure to do so will be considered a serious offence.

14. Excavations (if applicable)

	PROJECT SPECIFIC HEALTH AND SAFETY SPECIFICATION (SMALL PROJECTS)	ECDoE	T035
		Rev	00
		Date	31/07/2020
		Page	17 of 31

A procedure for managing excavations is to be provided as an addendum to the SSHSP describing how excavations are to be managed.

A competent person is to be appointed for managing all excavations. A permit system is to be available and used for all excavations. All equipment and ground conditions to be checked daily, and prior to work commencing.

Excavations should preferably not be open beyond what can be closed daily. Where excavations need to remain open, all excavations are to be properly protected. Adequate stakes with 1m high demarcation and berms/spoil are required to be a safe distance from the edge of the angle of repose. Candy tape may not be used to demarcate excavations. Cognisance is required of the surrounding area and increased levels of protection are required where work is in communities, near schools and clinics or churches.

Work will be stopped, and penalties applied to any work in excavations that is not compliant.

15. Working at heights (if applicable)

A fall protection plan is to be available and supplied as an addendum to the H&S plan. The fall protection plan must be appropriate for the project. Proof of competency must be on file for the Fall Protection Plan Developer and the appointment of a Fall Protection Supervisor with competency to be on file. Method statements, appropriate risk assessments, safe work procedures and training (all employees are to be in possession of a valid working at heights certification) are to be available prior to work commencing.

The focus for working at height shall include fall restraint systems where possible except during assembling or dismantling top components or where it is not deemed safe. The relevant SANS codes are to be applied as they apply to the works and the project, such as:

- SANS 10085
- SANS 10333 (parts 1-3)

Should part of the works be contracted out, competent Contractors are to be appointed and submit documentation according to the project requirements. The PC is to note if such work is to be contracted to specialists in the H&S Plan. The plan is to be developed and work managed by a competent person for the duration of the project. The following aspects must be included:

- The public or users of buildings are to be protected at all times by way of hoarding, barricading or fencing
- Notices to be posted
- Restrictions or stoppage when weather conditions are deemed hazardous
- Permit system for working at heights
- Prevention of falling tools or equipment
- Link to emergency plan regarding rescue

All workers are to be in possession of valid certificates of fitness that extend for the duration of the works. Note the requirements in the section relating to medical surveillance.

Registers and all relevant documentation are to be placed in the H&S file.

Work will be stopped, and penalties applied to any work at heights that is not compliant.

16. Cranes and lifting equipment (if applicable)

Lifting devices such as mobile cranes might be used during the project for deliveries, and moving of supplies or equipment,

	PROJECT SPECIFIC HEALTH AND SAFETY SPECIFICATION (SMALL PROJECTS)	ECDoE	T035
		Rev	00
		Date	31/07/2020
		Page	18 of 31

Appropriate documentation must be made available for the cranes and operators. Method statements, risk assessments, safe work procedures and training are to be available prior to work commencing. A procedure for managing loads and lifting must be made available as an addendum to the H&S Plan.

Chains, slings and webbing to have valid safe working load certification on file, should the documentation not be on site, the operation may be stopped, and fines imposed until such documentation may be delivered.

17. Temporary Works (Scaffolding, support work, formwork) (if applicable)

Temporary works must be properly designed and signed off by the PCs competent person for all temporary scaffolds, support work or formwork. In these instances, a competent person is defined as one who has sufficient experience in the design of the type of temporary work in question to be able to assess the design. The appropriate competent persons are to be appointed to manage and monitor such works to the satisfaction of the Engineer and PrCHSA. Records and registers are to be properly completed and kept in the H&S file. If temporary works are to be erected by a Contractor, this must be notified to the Principal Agent/PrCHSA.

Failure to do so will be considered a serious offence.

18. Auditing

Frequency of external auditing by the PrCHSA or Client will be bi-monthly to conform to the requirements of the Construction Regulations. The site will be inspected, and the documentation audited relative to the activities and H&S plan. The CHSO of the PC must accompany the Client, or the H&S Agent, on all audits and inspections. Not all audits will be, or need be announced.

The PC will ensure that all their Contractors are audited on a monthly basis, dependent upon the time to be spent on the site. Audit frequency may be increased if Contractors are not performing adequately. Audit results will be acted upon and non-conformances and penalties issued where deemed appropriate. The Client, Designer or PrCHSA may act or require further outcomes if non-compliances are noted or unsafe acts are noted on site.

Internal audits are to include site conditions as well as ensuring H&S files are appropriate, and compliant. Comprehensive audit reports are to be made available the format of the audit reports will be reviewed by the H&S Agent.

The PC will be audited using a template as supplied in the tender document. The audit template will be adjusted from time to time relative to the activities on site. A similar process is to be used by the PC when auditing their Contractors on site. Compliance with legislative requirements and the systems provided by the PC to manage the H&S on site will be measured. Full compliance is required. Time limits for corrective actions will be set and must be adhered to.

Failure to address findings or non-conformances will be considered a serious offence.

19. Communication and Meetings on Site

All H&S communication during the project between the PrCHSA and the PC will be done through the Principal Agent and be in writing, including the issue and responses to non-conformances and H&S audit results.

All update issues relating to COVID-19 will be required to be communicated at all levels.

	PROJECT SPECIFIC HEALTH AND SAFETY SPECIFICATION (SMALL PROJECTS)	ECDoE	T035
		Rev	00
		Date	31/07/2020
		Page	19 of 31

Meetings are to be held virtually where possible to limit exposure to COVID-19.

Failure to address issues timeously will be considered a serious offence.

20. Care of Workers on Site (Welfare)

Adequate toilets, clean, safe drinking water and weather protected shelter will be afforded workers at all times. Toilets will be within reasonable distance of workers, or placed with each working team in safe, with reasonable privacy.

Hand washing facilities, disinfectants and sanitizers will be provided across the site at common areas and entrances to work areas.

Arrangements for social distancing of 1.5m are to be made where existing facilities are shared with existing users must be made in writing and placed in the H&S file. Regular cleaning of all commonly used facilities, offices, and ablutions. Eating areas need to be cleaned prior to and post use. Staggered eating times are preferred, and note must be made of the chemicals used to clean the various areas. No plates, cups and glasses, or utensils may be shared. Water needs to be decanted or disposable cups used.

Failure to ensure compliance will be considered a serious offence, work will be stopped if con-conformances noted until corrected.

21. HEALTH AND SAFETY FILE

The documentation submitted and approved following the awarding of the contract will be used to form the H&S file. The H&S file is required to be laid out in a logical manner, and documentation filed within the file is to be easily accessible.

The following completed information shall be included (but not be limited to) as part of the index:

- The SSHSS;
- The SSHSP and the approval by Client;
- Appointment by Client;
- Mandatory agreement with Client;
- Notification of construction work;
- A record of all working drawings, calculations and design where applicable;
- Detailed list of Contractors with contact details, appointments, Mandatories etc., H&S specifications issued;
- Record of Competencies (CVs) and appointments;
- Training Records;
- Permits;
- Method statements;
- Risk assessments;
- Safe work procedures;
- Emergency and injury management;
- Safety data sheets
- Medical surveillance records;
- Registers;
- Records of audits, minutes etc.;

	PROJECT SPECIFIC HEALTH AND SAFETY SPECIFICATION (SMALL PROJECTS)	ECDoE	T035
		Rev	00
		Date	31/07/2020
		Page	20 of 31

- Plant lists;
- Temporary electrical installations, and
- Employee records (who is on site).

22. NON-CONFORMANCES

Should, at any time, the works, or part of the works, be stopped due to unsafe acts or non-compliance with the Clients or PCs H&S Plan; neither the PC nor any other Contractor shall have a claim for extension of time or any other compensation.

The following constitute examples of the types of non-conformances that will attract penalties:

Minor: Penalty: R50/count	Medium: Penalty: R500/count and a non-conformance	Severe Penalty: R5000/count, a non-conformance and/or activity stoppage
Non-use of PPE supplied	Toilets not supplied or regularly serviced; lack of drinking water	Contractors working without Health and Safety Plan approval
Non-completion of registers for plant and equipment on site	Contractors not audited	Workers transported in contravention of the OHS plan or legal requirements
Lack of H&S signage at work areas	Working without training or the appropriate, approved H&S method statements	Invalid Letters of Good Standing
Tools and equipment identified in poor condition during inspections	Legal non-conformances identified during the previous audit and not addressed within the agreed time frame	Non-compliance with traffic accommodation requirements: layout or physical conditions
	No monthly OHS report at site meeting to report on	Any serious breach of legal requirements
	No certificates of fitness for workers as required	
	Working without approved method statements	

23. Failure to Comply with Provisions

Failure or refusal on the part of the PC or their Contractors to take the necessary steps to ensure the safety of workers and the general public in accordance with these specifications or as required by statutory authorities or ordered by the engineer, shall be sufficient cause for the engineer to apply penalties as follows:

- A penalty as shown in the Table above shall be deducted for each and every occurrence of non-compliance with any of the requirements of the SSHSS,
- In addition, a time-related penalty of R500,00 per hour over and above the fixed penalty may be deducted for non-compliance to rectify any non-conformance within the allowable time after a site instruction to this effect has been given by the Designer. The site instruction shall state the agreed time, which shall be the time in hours for reinstatement of the defects. Should the Contractor fail to adhere to this instruction, the time-related penalty shall be applied from the time the instruction was given.

 Province of the EASTERN CAPE EDUCATION	PROJECT SPECIFIC HEALTH AND SAFETY SPECIFICATION (SMALL PROJECTS)	ECDoE	T035
		Rev	00
		Date	31/07/2020
		Page	21 of 31

24. Public safety

The Principal Contractor shall ensure at all times that staff, and general public are aware of the dangers and risks involved whilst construction is taking place.

- Safety signage / posters shall be posted at all areas where construction work is taking place;
- Edges, excavations, stockpile areas, material storage areas, will be demarcated and no entry signage appended;
- Safety talks with employees shall be done, all employees shall be involved in keeping the site safe;
- CLO shall be given talks to do with the community members who are directly involved;
- A record of all training shall be kept, and indemnity documents shall be signed by those attending the safety talks.
- Community unrest shall be handled by the local SAPS. CLO shall assist the Contractor should the need arise.
- No visitors to site are allowed unless proper arrangements are made.

 Province of the EASTERN CAPE EDUCATION	PROJECT SPECIFIC HEALTH AND SAFETY SPECIFICATION (SMALL PROJECTS)	ECDoE	T035
		Rev	00
		Date	31/07/2020
		Page	22 of 31

**ANNEXURE A
 PrCHSA AUDIT SHEET**

EXAMPLE OCCUPATIONAL HEALTH AND SAFETY AUDIT DOCUMENT

PROJECT NAME:	
CONTRACT NUMBER:	
HEALTH AND SAFETY AUDIT No:	
CONDUCTED BY :	
DATE :	

	PROJECT SPECIFIC HEALTH AND SAFETY SPECIFICATION (SMALL PROJECTS)	ECDoE	T035
		Rev	00
		Date	31/07/2020
		Page	23 of 31

EXECUTIVE SUMMARY

INTRODUCTION AND OVERVIEW

Scoring:

The audit has a scoring schedule, which will be used to deem compliance to what is available on site, and what the appropriate systems need to be to match them. The contractor should aim for a score of 3 on each aspect included in the audit. A low score could result in part or all of the work being stopped until compliance is reached.

Scoring schedule	
If the answer is " No " the rating will be 0	
If the answer is ' not applicable ' it will be noted as n/a	
If the answer is " Yes " the following ratings are applicable	
1	Requirements partially met and no implementation.
2	Requirements partially met and partially implemented
3	Requirements fully met and partially implemented
4	Requirements fully met and fully implemented
5	Requirements and implementation exceed expectation

Key Abbreviations:

Health and Safety	H&S	Occupational Health and Safety Act	OHSA
Occupational Health	OH	Mine Health and Safety Act	MHSA
Construction Regulations	CRs	Driven Machinery Regulations	DMRs
General Safety Regulations	GSRs	Regulations for Hazardous Chemical Substances	RHCSs
Explosive Regulations	ERs	Pressure Equipment Regulations	PERs
Noise Induced Hearing Loss Regulations	NIHLs	Department Mineral and Energy	DMEs
Facilities Regulations	FRs	General Administration Regulations	GARs
South African Bureau of Standards	SABS	South African National Standards	SANS
Joint Building Conditions of Contract	JBCC	South African Road Traffic Safety Manual	SARTSM

Provide a summary of site inspection, significant findings of the site inspection and the audit findings.

	SITE SPECIFIC HEALTH AND SAFETY SPECIFICATION	cd&a	T002a
		Rev	00
		Date	07/02/2020
		Page	24 of 31

CORE LEGAL RECORDS ON SITE:

THIS LIST IS NOT CONCLUSIVE – TO BE UPDATED MONTHLY RELATIVE TO WORKS IN PROGRESS. HOWEVER THE CHSO IS TO BE PRO-ACTIVE AND PRE-EMPT REQUIREMENTS WITH THE CONSTRUCTION SUPERVISOR (SITE AGENT). THE CONTENT WILL BE LINKED TO THE PHYSICAL CONDITIONS, PROCESSES AND ACTIVITIES NOTED ON SITE, OR PROGRAMME.

ITEM	Legal /SPEC Ref	RECORDS TO BE KEPT	SCORE	COMMENTS	By whom	Completion Date	Contractor Close out
		Updated project H&S Organogram					
	OHSA S. 16 (1) and (2)	CEO and subordinate (if required) CVs on file					
	CR 6 (1) and (2)	Designation of Construction Supervisor(s) and Subordinate Person(s) CVs on file					
	OHSA S. 17; GAR 7	H&S Representatives appointed Monthly inspections completed Representation from Contractors					
	OHSA S. 18; GAR 5	H&S Committee appointed Minutes on file H&S representatives reports discussed Incidents discussed Signed by Chair/CEO Evidence of minutes noted					
	GAR 4	Copy of OH&S Act (Act 85 of 1993) Available on site					
	CR 4 (c), 5 (f)	Written proof of registration / Letters of good standing available on Site					
	OHSA S.37.2	Copy of the Mandatory (S37.2) agreement between the PC and Client					
	OHSA S.37.2	Mandatory agreements between PC and contractors					

**PROJECT SPECIFIC HEALTH AND SAFETY SPECIFICATION
(SMALL PROJECTS)**

ECDoE	T035
Rev	00
Date	31/07/2020
Page	25 of 31

ITEM	Legal /SPEC Ref	RECORDS TO BE KEPT	SCORE	COMMENTS	By whom	Completion Date	Contractor Close out
1.	CR 3(3)	Notification to Provincial Director – Annexure A Available on site					
2.	CR 4(3) 5 (7)	Copy of Principal Contractor’s Health & Safety Plan Available on request. Letter of approval from Agent. Health & Safety File opened and kept on site (including all documentation-required in respect of the OHS&A Regulations Available at all times					
3.	CR 5(6) (9)	Copy of Principal Contractor’s Health & Safety Plan provided to Contractors Letters of approval for each contractor on file List of Contractors on site Verified monthly by Agent					
4.	CRs	Copies of technical method statements approved by Designer Register available, signed by Designer					
5.	CR 7(2) OHS&A CR 7(4)	Risk Assessments: Up to date and available on site for inspection Review and monitoring programme adhered to Workers trained in risk assessments					
6.	CR 7 (c)	Safe work procedures Procedure List of available SWPs Workers trained in SWPs Proof of training verified					
7.	OHS&A S. 13 CR 7(9)	Induction programme available Proof of induction training available					
8.	CR 9(2) (b) (3)	Structural information from Designer: Geo-science technical report					

**PROJECT SPECIFIC HEALTH AND SAFETY SPECIFICATION
(SMALL PROJECTS)**

ECDoE	T035
Rev	00
Date	31/07/2020
Page	26 of 31

ITEM	Legal /SPEC Ref	RECORDS TO BE KEPT	SCORE	COMMENTS	By whom	Completion Date	Contractor Close out
		Design loading of the structure Methods & sequence of construction Design risk assessment Amended H&S Specification					
9.	CR 11(3)(h)	Excavations: Competent persons appointed CVs available Depth of excavations on site Shoring in use Registers in line with open excavations noted at site inspection					
10.	CR 11 (f) GSR 13A	Ladders: Competent person appointed Registers kept Registers for ladders noted on site					
11.	CR 21	Construction Vehicles: Appointment of competent operators Plant Management: Registers on file noting daily inspections Plant and machine list available Inadequacies noted on site Transportation of workers Registers for sample of vehicles noted on site					
12.	CR 25, 26 ER 6 GSR 8	Housekeeping, Stacking & Storage Supervisor: Appointed per work area CVs Available Include site conditions Spoil areas Register available per area					
13.	GSR 2	PPE: included in Risk Assessment PPE used and enforced Records of Issue kept Training to use (Induction)					

**PROJECT SPECIFIC HEALTH AND SAFETY SPECIFICATION
(SMALL PROJECTS)**

ECDoE	T035
Rev	00
Date	31/07/2020
Page	27 of 31

ITEM	Legal /SPEC Ref	RECORDS TO BE KEPT	SCORE	COMMENTS	By whom	Completion Date	Contractor Close out
		Registers for condition checks					
14.	RHCSs CR 7; 23 GSR 4	Hazardous Chemical Use and Storage Competent Person/s appointed CVs available Risk Assessments include use of HCSs Register of HCS kept/used on Site Flammable Store Bulk diesel storage Material Safety Data Sheets on file and utilised Other					
15.	GSR 3	Emergency management: First aiders available through project Level 3 First aid boxes through site Evacuation procedures Registers available (noted on site)					
16.	GAR	Incident Management: Emergency co-ordinator appointed CV available Emergency plan appropriate Emergency level included in Risk Assessments Workers trained Incident reports available and complete					
17.	CRs RHCSs GSR 2(a) MHSA	Medical Surveillance Programme Pre-placement Periodic Exit Workers at height Plant operators Random drug testing DME Annual Medical report					
18.	CR / FRs	Welfare Facilities: Toilets available where crews are working/clean Clean potable water available					



ITEM	Legal /SPEC Ref	RECORDS TO BE KEPT	SCORE	COMMENTS	By whom	Completion Date	Contractor Close out
		Adequate eating facilities					
19.		HIV AND AIDS PROGRAMME HIV and AIDS Policy and plan available Condoms available Peer review programme available Ongoing training of workers					
20.		<p>Covid-19 Management</p> <p>Policy in place The COVID-19 plan approved Have risk assessments been done? Have HIRA and Policy been submitted to the H&S Committee, and evidence thereof? Have HIRA and Policy been submitted to DEL? Sharing of the DEL Directive and implementation? Have employees / Contractors been notified of actions if ill or COVID-19 symptoms? Discipline of employees/Contractors if deviation Is the supervision and monitoring in progress and is visible Signage re symptoms, visitors, emergency contacts, PPE and prevention measures up across the site and critical areas The procedure for positive</p>					



**PROJECT SPECIFIC HEALTH AND SAFETY SPECIFICATION
(SMALL PROJECTS)**

ECDoE	T035
Rev	00
Date	31/07/2020
Page	29 of 31

ITEM	Legal /SPEC Ref	RECORDS TO BE KEPT	SCORE	COMMENTS	By whom	Completion Date	Contractor Close out
		COVID-19 in place Tracing of contacts if needed Social distancing in place for workplaces and facilities, meetings Report to COIDA if a positive case contracted at work Issue of masks and other PPE noted in HIRA Training of wearing of masks Visitors have PPE available Enforcement of wearing of PPE and social distancing Ventilation – air conditioning or means of ventilation in offices, workshops and meeting areas					

RESPONSIBILITY	SIGNATURE	DATE
PrCHSA SIGNATURE:		
PC SIGNATURE:		
DESIGNER SIGNATURE:		
CLIENT SIGNATURE:		

claire deacon & associates The Health & Safety Specialists 	SITE SPECIFIC HEALTH AND SAFETY SPECIFICATION	cd&a	T002a
		Rev	00
		Date	07/02/2020
		Page	26 of 31

ANNEXURE B CLOSE OUT REQUIREMENTS

The H&S files for the Principal Contractors and all Contractors require closure and handover to the Client at the completion of the project. The following list is an example of what should be included but is not exhaustive. The OHS Agent or the Client may require further information at the time of completion and the Principal Contractor is to ensure that all instructions are met. Documentation would include all records from the start of the project. Daily or monthly plant inspection records are not required unless they are related to an accident. All records to be in electronic format and submitted to the OHS agent for approval in adequately formatted lists and folders. Layout should be logical and in the same order as in the site files.

Health and Safety close out file requirements include:

- a) Client H&S Specification
- b) Principal Contractor's OHS Plan(s)
- c) Organograms
- d) Legal Appointments
- e) List of all employees employed on a permanent or contractual basis over the duration of the contract
- f) Notification to Department of Labour of commencement of work
- g) Letters of Good Standing for the Project
- h) Full files for all Contractors as well as their close out reports
 - List of Contractors
 - All employees employed on a permanent or contractual basis over the duration of the contract
 - Letters of Approval of Contractors
 - Mandatary Agreements
 - Letters of Good Standing
 - Appointments
- i) Incident Records
- j) Non- Conformance records
- k) Agent's Audits
- l) Method Statements
- m) Risk assessments
- n) Safe work procedures
- o) Medical surveillance certificates of fitness. Medical records are to be kept according to the OH&S Act as amended
- p) All drawings for temporary structures (suspended beams/scaffolds etc.)
- q) All operating manuals for any systems that require ongoing maintenance
- r) Copies of test results, policies and procedures for environmental monitoring (silica, noise, dusts etc.)

Defect and Liability Period

The H&S files are to be kept 'live' for the defect and liability period by the Principal Contractor, including those of their Contractors. Any work required during the defect and liability period will require an assessment of the H&S file by the OPrCHSA prior to any work commencing.

A copy drawing records for the as-builts are to be placed on file by the Designers once complete.

claire deacon & associates The Health & Safety Specialists 	SITE SPECIFIC HEALTH AND SAFETY SPECIFICATION	cd&a	T002a
		Rev	00
		Date	07/02/2020
		Page	27 of 31

ANNEXURE C NON-CONFORMANCES

HEALTH AND SAFETY SITE INSPECTION NON-CONFORMANCE NO		
AGENT:	PROJECT:	
Consultant:	Date and time:	
Client	Area:	
Contractor:		
ASPECTS NOTED:	COMMENTS:	COMPLETION REQUIRED BY (DATE):
	•	
	•	
	•	
	•	
	•	
PHOTOGRAPHIC EVIDENCE (if available):		
OTHER:		
The following penalties are to be applied:		
Signature of Designer		
Signature of CHSO/Site Agent		
Signature: of H&S Agent		

C3.4 Contractors Reports

CONTRACTOR MONTHLY REPORT

PART 1

Project No: Project Name:

Contract No:

Contractor Name:

Claim No: For Period Ending:

Date of Report:

The Contractors monthly report comprises an integral part of the Contractors payment claim and processing of the payment claim is not permitted without this report also being submitted i.e.

“NO REPORT – NO PAYMENT”.

Attachments:

Part 2 : Overall Project Worker Schedule: Schedule of all local labourers employed since the start of the project

Part 3 : Weekly Task Wage Register

Part 4 : Local Labour Schedule

Part 5 : Beneficiary List (certified copy of ID's)

Additional Requirements:

1. When contractor recruit local labourers, they must produce a 13 digit identity document and a certified copy of the ID must be forwarded to the DRPW Regional EPWP representative
2. That at least one disabled person be recruited and employed on the project and reported as such
3. A daily attendance register should be kept on site
4. Each beneficiary must **sign** the payment sheet, as proof that they have been paid.
5. At the bottom of the contractors report, the site agent or CLO or contractor must sign the document as proof that the people indicated have worked the number of days
6. Employment of local labourers should constitute the following:
 - a. 55% women
 - b. 55% young people
 - c. the minimum wage rate to be paid is R180.00 per day per person or higher

OVERALL PROJECT WORKER SCHEDULE (local labourers only)

Contract No: PART 2

Project No.

Project Name:

Month of Report:

Sheet: of

Names of all **Local Workers** employed **at any time on the project** are to be entered in the table below irrespective of how long they worked on the project.

No.	Name of Local Labourer	Identity Number	Month Worker Started	Age	Tick if Yes									Place a tick in the box which corresponds to the Gender and Age of the Worker						
					Female Head of Household with Dependants	Disabled	Labourer	Semi-Skilled	Skilled	Supervisor	Clerical	Managerial	Professional	Women		Men				
														Over 35 yrs 2A	35 yrs & under 2B	Over 35 yrs 2C	35 yrs & under 2D			
Totals for this sheet																				Total No. of workers Employed on the Project
Totals from previous sheet																				
Totals carried forward																				

(A) (B) (C) (D) (E) (F) (G) (H) (I) (J) (K) (L) (M) (N) = (J+K+L)

NOTE: LOCAL LABOUR TARGETS TO BE ACHIEVED WITH REGARD TO EPWP RELATED WORKS: Women = 55%; Youth = 55%; Disabled = 2%

Completed by: Name: Signature:..... Capacity Date:.....

LOCAL LABOUR AND MATERIAL SCHEDULE

PART 4

Contract No: Date of Report:
 Project No: Project Name:
 Claim No: For Period Ending:
 Contractor Name:

1. Summary of Day Tasks worked and Amount Spent on Local Labour this month

Week No.	Week Ending	Total Day Tasks / Person Days Worked	Total Amount Paid
		(Total of (A) from Form 4 for each week)	(Total of (B) from Form 4 for each week)
1			R
2			R
3			R
4			R
5			R
6			R
7			R
8			R
9			R
Total			R

Transfer to 2 in table below

2. Summary of Amount Spent on Local Labour to date

1. Previous Amount Spent on Local Labour (From previous claim)	R
2. Amount Spent on Local Labour this month (From Total above)	R
3. Total Amount Spent on Local Labour to date (3)=(1+2)	R

3. Local Labour Schedule

Summary of Local Labour Employed	No. of local workers who worked on the project to date (From Part 2)	% of Total
Columns refer to Columns in Part 2		
1. Total No. of individual local workers who have worked on the Project (Column N)		100%
10. How many of the Total No. are local youth (35 yrs and under) (Column B & D)		
11. How many of the Total No. are local women (Column A + B)		

4. Summary of Amount Spent on Material to Date (Cumulative)

Item	This Month	Total to date
1. Material from Local Municipality		
2. Material from Local District Municipality		
3. Material from Outside the Eastern Cape		
4. Material from other areas within the Eastern Cape		
Total Material		
Total material as percentage of contractor expenditure		
Total as percentage of contractor budget		

Training of Local Workers

Category of training	Name of course	No. trained	Days trained	Comments on progress
(a) Technical training for implementation	Bricklaying			
	Carpentry			
	Plumbing			
	Fencing			
	Plastering			
	Painting			
	House Building			
	Handyman			
	Electrical			
(b) Institutional training for local management beyond construction				
(c) Technical training for OMM				
(d) Institutional training for implementation				
(e) HIV/ Aids etc.				
Other – Please specify				
Total				

NOTE: LOCAL LABOUR TARGETS TO BE ACHIEVED WITH REGARD TO EPWP RELATED WORKS: Women = 55%; Youth = 55%; Disabled = 2%

Completed by:

Name

Signature

Capacity

Date

Part 5: Pricing Data

C2.1 Pricing Instructions

C2.1: PRICING INSTRUCTIONS JBCC 2000 PRINCIPAL BUILDING AGREEMENT (Edition 4.1 of March 2005)

Project title:	PREFABRICATED STRUCTURE RELIEF PROGRAMME: SUPPLY AND ERECT TWO CLASSROOM BLOCK AT AMAZIZI SENIOR SECONDARY SCHOOL
Bid No:	2022/07/065

1. BILLS OF QUANTITIES

The **bills of quantities** forms part of and must be read and priced in conjunction with all the other documents forming part of the **contract documents**, the Standard Conditions of Bid, Conditions of Contract, Specifications, Drawings and all other relevant documentation.

2. VALUE ADDED TAX

The bid price must include for Value Added Tax (VAT). All rates, provisional sums, etc. in the **bills of quantities** must however be net (exclusive of VAT) with VAT calculated and added to the Total Value thereof in the Final Summary.

3. PREVIOUS WORK

The bidder is to acquaint themselves with the site thoroughly before pricing. Adjustment of prices will not be entertained after the award of the contract.

C2.2 Preliminaries / Bill of Quantities / Final Summary

Item No		Quantity	Rate	Amount
	<p><u>PRELIMINARIES</u></p> <p>The JBCC Preliminaries Code 2103, May 2005 edition for use with the JBCC Principal Building Agreement Edition 4.1 Code 2101, March 2005 is taken to be incorporated herein. The tenderer is deemed to have referred to these documents for the full intent and meaning of each clause.</p> <p>Fixed: _____ Value related: _____ Time related: _____</p> <p><u>ALTERNATIVE BUILDING TECHNOLOGY</u></p> <p>The Tenderer is referred to the relevant Clauses in the separate document Model Preambles for Trades (1999 Edition), the Department of Public Works document No. PW 371 Specification of Materials and Methods to be used and to the Supplementary Preambles which are incorporated at the front of these Bills of Quantities.</p> <p>The Tenderer must make reference to Architects Drawings attached for desired layout and look.</p> <p>All prices for the Prefabricated Building Bill of Quantities must include for all establishment and overhead charges to be incurred by the specialist supplier and sub-contractor. No additional charge will be entertained by the Employer for failure to price accordingly.</p> <p><u>SUPPLEMENTARY PREAMBLES</u></p> <p><u>Proprietary products in descriptions:</u></p> <p>Proprietary products shall be used as specified. Substitute products of similar quality and specification may only be used with prior approval by the Principal Agent.</p>	Item		
	Carried to Collection		R	
	Bill No. 1 Alternative Building Technology			

PREFABRICATED BUILDING STRUCTURES

NOTE: All the alternative building technology buildings are design build therefore the contractor must employ a competent qualified design team for the design, construction supervision and commissioning of the buildings. The Modular Structures Specifications for Design, Manufacture, Supply, Deliver and Erect Prefabricated Structures attached to these Bills must be applied by the design team. JBCC principal building agreement clause will not apply on the alternative building technology buildings.

Description of erection process:

All material, workmanship, etc are to be of highest quality and must comply with SANS 10400 and SANS 204:2011.

A Temporary Floor Construction Method is to be used for this Project, where temporary suspended floors constructed out of 19mm Treated Shutterboard (or similar approved) are placed on an Engineer Designed Galvanised Steel Structure.

The area under the floor structure is to be closed off with a durable side wall material.(Breathable Allow for Ventilation)

Shop drawings and designs:

Successful Contractor must provide the Principal Agent with shop drawings and floor designs before commencing with works on site. The Contractor must resume with the works only after the Client / Principal agent has approved the design of the buildings.

Carried to Collection

Bill No. 1
Alternative Building Technology

R

Quality certificates:

1. Contractor must provide compaction certificate for density.
2. Certificate of compliance for fire Extinguishers.
3. Contractor must provide a structural walling certificate.
4. Contractor must provide a roof covering certificate. 5. Contractor must provide a certificate of compliance for electrical installation.
6. Contractor must provide a lighting protection certificate where applicable.
7. Contractor must provide a commission certificate for the entire building, it must also confirm the life expectancy of the building which be not less than 50 years.

Two (2) Classroom block “Prefabricated structure”

1 Construction of prefabricated structure for classrooms **(60m2 per classroom)** building size 17,180mm x 8,880mm wide x 3,000mm high overall, building width is **inclusive of verandah 1,600mm wide** with verandah poles encased in concrete.(Floor Construction Temporary)Prefabricated structure complete including prefabricated walling, doors, windows, ceilings, roofs, Electrical and finishes. Structure to conform to the NHBRC and SANS standards. Each classroom must have a pinning board size 4800 x 1200mm high, steel cabinet 900 x 450 x 1800mm high and chalk board size 4800 x 1200mm high. The structures must also include barge boards, fascia boards, gutters and downpipes.

Refer to T2.2W for further specifications

No

1

Carried to Collection

R

Bill No. 1
Alternative Building Technology

**PREFABRICATED CLASSROOMS
DEPARTMENT OF EDUCATION EASTERN CAPE**

Bill No. 1

Alternative Building Technology

COLLECTION

Total Brought Forward from Page No.

**Page
No**

1

2

3

Amount

Carried to Summary

R

Bill No. 1

Alternative Building Technology

**PREFABRICATED CLASSROOMS
DEPARTMENT OF EDUCATION EASTERN CAPE**

Item No	Labour Ref		Unit	Quantity	Rate	Amount
		<p><u>EXTERNAL WORK (PROVISIONAL)</u></p> <p>The Tenderer is referred to the relevant Clauses in the separate document Model Preambles for Trades (1999 Edition), the Department of Public Works document No. OW 371 Specification of Materials and Methods to be used and to the Supplementary Preambles which are incorporated at the front of these Bills of Quantities.</p> <p><u>SUPPLEMENTARY PREAMBLES</u></p> <p><u>Proprietary products in descriptions:</u></p> <p>Proprietary products shall be used as specified. Substitute products of similar quality and specification may only be used with prior approval by the Principal Agent.</p> <p><u>BULK EARTHWORKS, PLATFORMS, CUT-OFF DRAINS, ETC</u></p>				
1	LI	<p><u>Clearing of site:</u></p> <p>Allow for clearing the area of the site to be built upon of all grass, weeds, shrubs, trees with trunks not exceeding 200mm girth, debris, etc., including grubbing up all roots, scoffling up as required and cart away all vegetation and debris.</p>	m2	192		
2	LI	<p><u>Open face excavation not exceeding 2m deep:</u></p> <p>Over site to reduce levels and depositing excavated material in prescribed stock piles on site.</p>	m3	29		
		Carried to Collection				R
		Bill No. 2 External Work				

		<u>Extra over bulk excavation in earth for excavation in:</u>			
3		Soft rock.	m3	3	
4		Hard rock.	m3	1	
		<u>Extra over all excavations for carting away:</u>			
5		Surplus material from stock piles on site to a dumping site to be located by the contractor.	m3	29	
		<u>Keeping excavations free of water:</u>			
6		Keeping excavations free of water.		Item	
		<u>Earth filling supplied by the contractor under pavings etc.</u>			
7		Over site of G7-SUBGRADE material compacted to 95% Mod A.A.S.H.T.O. density.	m3	29	
	LI	<u>Compaction of surfaces.</u>			
8		Compaction of ground surface under roads etc including scarifying for a depth of 150mm, breaking down oversize material, adding suitable material from excavated material where necessary and compacting to 95% Mod AASHTO density.	m2	192	
	0	<u>PROTECTION AGAINST TERMITES</u>			
	0	<u>Soil insecticide:</u>			
9	0	Under floors, etc including forming and poisoning shallow furrows against foundation walls, etc and filling in furrows and ramming	m2	192	
		<u>STORMWATER CHANNELS</u>			
		Carried to Collection			
		Bill No. 2 External Work			R

10	<p><u>Precast concrete finished smooth on exposed surfaces including bedding, jointing and pointing:</u></p> <p>150 x 240mm high x 145mm internal diameter Precast Half-Round Channel (30Mpa) with 30mm Mortar infill between channel and brickwork on 75mm thick 3:1 (sand/cement) bedding projecting 100mm beyond channel including all necessary excavations, backfilling, compaction, carting away, etc.Code (CH2103)</p>	m	16	
11	<p>Extra over for angles, intersections, ends, dressing into sides of catchpits, etc.</p> <p><u>WALKWAYS AND VERANDAH</u></p> <p><u>Earth filling supplied by the contractor under pavings etc:</u></p>	No	4	
12	<p>Over site of SUBGRADE (G6) material compacted to 95% Mod A.A.S.H.T.O. density.</p> <p><u>Prescribed density tests on filling:</u></p>	m3	5	
13	<p>In-situ dry density test.</p> <p><u>Paving of 100 x 200 x 60mm bevelled Interlocking Pavers (SLATE) laid in stretcher bond on and including 20mm thick sand bed:</u></p>	No	4	
14	<p>Paving to walkway areas etc to falls.</p>	m2	32	
15	<p>1:6 sand/cement mix is to be swept into joints between concrete pavers.</p>	m2	32	
16	<p>Extra over ordinary paving for 200mm wide block-on-flat header course edging on 100mm thick mortar bed including unreinforced concrete haunching along outside edge.</p>	m	23	
	Carried to Collection			R
	<p>Bill No. 2 External Work</p>			

**PREFABRICATED CLASSROOMS
DEPARTMENT OF EDUCATION EASTERN CAPE**

Bill No. 2 External Work <u>COLLECTION</u> Total Brought Forward from Page No.	Page No 5 6 7	Amount <hr style="border-top: 1px dashed black;"/> <hr style="border-top: 1px dashed black;"/> <hr style="border-top: 1px dashed black;"/>
Carried to Summary		R
Bill No. 2 External Work		

**PREFABRICATED CLASSROOMS
DEPARTMENT OF EDUCATION EASTERN CAPE**

Item No		Quantity	Rate	Amount
	<u>PROVISIONAL AMOUNTS</u>			
	<u>ELECTRICAL INSTALLATION</u>			
1	Provide the amount of R30,000.00 (Thirty Thousand Rand) for Electrical Connection.	Item		30,000.00
2	Allow for profit.	Item		
3	Allow for attendance.	Item		
	<u>COMMUNITY LIAISON OFFICER</u>			
4	Allow the sum of R 15,000.00 (Fifteen Thousand Rand) for the placement of a Community Liaison Officer to be employed by the Main Contractor for duration of Contract.	Item		15,000.00
5	Allow for attendance.	Item		
	Carried to Summary			
	Bill No. 3 Provisional Sums		R	

**PREFABRICATED CLASSROOMS
DEPARTMENT OF EDUCATION EASTERN CAPE**

Bill No		Page No		Amount
<u>FINAL SUMMARY</u>				
1	Alternative Building Technology	4		
2	External Work	8		
3	Provisional Sums	9		
<u>CONTINGENCIES</u>				
	Allow the sum of R10,000.00 (Ten Thousand Rand) for Contingencies to be used or deducted in full at the Principal Agent's discretion.		R	10,000.00
	Sub Total		R	
	Add Value Added Tax at the rate of 15%		R	
	Carried to Form of Tender		R	

C2.3 SPECIFICATION PREFABS (T2.2W)

**NOTE: TENDERER TO SIGN EACH PAGE AND RETURN WITH
BID/TENDER INCLUDING THE DESIGN MANUAL COMPLYING WITH
T2.2W**

GENERAL SPECIFICATION

INDEX

		<u>Page no.</u>
1.	GENERAL	2
2.	CLASSROOMS, OFFICE AND STORE	3
2.1	PHYSICAL REQUIREMENTS	3
2.2	FOUNDATIONS	3
2.3	FLOOR CONSTRUCTION	4
2.4	EXTERNAL AND INTERNAL WALLING	6
2.5	ROOF CONSTRUCTION AND COVERING	8
2.6	CEILINGS	10
2.7	FLOOR COVERING	10
2.8	PLASTERING	10
2.9	ELECTRICAL INSTALLATION	10
2.10	GLAZING	14
2.11	PAINTING	15
2.12	SUNDRIES	15
2.13	EXTERNAL WORKS	16
2.14	FENCING	17

1. GENERAL

- 1.1 All materials, workmanship, etc are to be of the highest quality and must comply with the relevant SANS specification (SABS 0400 – 1990, SA Standard Code of Practice for the application of National Building Regulations) etc and the Specification of Materials and Methods used (PW371), which is obtainable from the Department of Public Works, and shall be read in conjunction with the Bills of Quantities and shall be referred to for the full descriptions of work to be done and materials to be used.
- 1.2 The structure must comply with all municipal, and fire regulations, etc and it is the responsibility of the contractor to comply with these regulations.
- 1.4 On completion of the project, the contractor must issue to the employer the following certificates:
 - 1.4.1 Certificate of Compliance relevant Installer as to the suitability of design as per item 2.2, 2.3 and 2.4.
 - 1.4.3 All certificates required to be issued by the local Municipalities.
 - 1.4.4 The contractor must supply certificates for the treatment of all timber against termites and dry rot.
 - 1.4.5 Roof truss certificate - see 2.5
- 1.5 The Contractor must be registered with the CIDB, proof of registration must be submitted with the tender documents or JV Partner.
- 1.6 The Contractor must be registered with the CIPRO, proof of registration must be submitted with the tender documents.
- 1.7 The Contractor must submit a valid original Tax Clearance certificate.

The contractor must include for all items that may be required to ensure a functional building to comply with the building regulations

2. CLASSROOMS, OFFICE AND STORE

2.1 PHYSICAL REQUIREMENTS

- 2.1.1 Classrooms shall be a minimum of 60m² in size and the length to breadth ratio must be able to fit a total of 20 school desks (1000x450mm), 1 teachers desk, 1 cupboard, with adequate space for chairs and circulation. The floor to ceiling height shall not be less

than 2.70 m above finished floor level. A covered verandah 1,5 m wide must be constructed for the entire length to the entrance side of the building.

- 2.1.2 Office and Store shall have a combined minimum area of 30m². A wall with a semi-solid door should divide the rooms. The floor to ceiling height shall not be less than 2.70 m above finished floor level. A covered verandah 1,5 m wide must be constructed for the entire length to the entrance side of the building.

2.2 **FOUNDATIONS**

No soil tests are available. The contractor to undertaken their own soil testing to determine the size and type of foundations required. All foundations must be designed by a Registered Engineer, who must issue an approval certificate at completion. Two foundation construction methods are recommended, a) Strip footings and b) Raft foundations. The contractor to supply foundations details with his tender.

All surfaces under buildings to be treated with termite proofing. The contractor to supply a certificate from registered applicators.

2.2.1 **STRIP FOOTINGS**

- 2.2.1.1 The minimum size of strip footing assumed to be 700 x 250mm. The depth of excavation from formation level is 750mm, if due to soil conditions the depth is increased or decreased; the cost to the contractor will be adjusted based on the schedule of rates.
- 2.2.1.2 All concrete in footings to have minimum 28 day strength of 20MPa and the contractor must supply test cube results to comply for every 24m³ of concrete cast. The first set of cubes to be tested at 7 days with the minimum required 7 day test strength of 13 MPa and if the tests comply with these specifications then the remaining cubes to be tested at 28 days for a minimum 28 day strength of 20MPa.
- 2.2.1.3 All foundation brickwork to be 220mm wall of well burnt bricks, with a minimum strength of 14MPa. Foundation walls to project a minimum of 300mm above the finished platform level or natural ground level. Brick force to be supplied in every course and shall be galvanised welded fabric formed of two hard drawn wire of diameter not less than 2.8mm and not more than 3.55mm held apart by cross wires at 300mm centres.
- 2.2.1.4 The exposed plinth to be constructed with hard burnt face bricks, quality of a FBS brick, of an approved colour and a minimum strength of 14 MPa.
- 2.2.1.5 The damp proof course to be 375 micron embossed waterproof sheeting.
- 2.2.1.6 All backfilling of trenches to be of suitable granular materials in maximum 150mm thick layers and compacted to 95% mod AASHTO.

2.2.2 RAFT FOUNDATIONS

- 2.2.2.1 The foundation to be constructed according to the Engineer's specification and Design.
- 2.2.2.2 The Design to comply fully with the National Building Regulations, SABS 0161, the Joint Structural Division (SAICE/IStructE)'s Code of Practice, and the NHBRC's Home Building Manual.
- 2.2.2.3 All concrete to be a minimum of 25MPa and the design of the Raft Foundation to cater for the required differential heave as determined by the Soils Investigation.
- 2.2.2.4 The contractor to provide details of a raft foundation designed for a differential heave of 15mm. The details provided must include beam sizes, beam spacing, floor slab thickness and reinforcing. The cost of any deviation from this due to an increased or decreased differential heave will be adjusted based on the schedule of rates.

2.3 FLOOR CONSTRUCTION

Two types of floor construction must be considered. Concrete floors for buildings with an accepted life period of more than 24 months, and a temporary, movable floor construction for a building that should be moved within 24 months of construction. There must be a step of a minimum height of 170mm between the Finished Floor Level or Walkway level and the level of the Platform.

2.3.1 CONCRETE FLOORS

- 2.3.1.1 The platform under the slab is to be compacted to a minimum of 95% mod AASHTO density.
- 2.3.1.2 An approved fill should be used under the slab, (selected from the excavated material on site or imported material) and to be deposited in layers not exceeding 150mm thick, well watered and compacted to 95% mod AASHTO density.
- 2.3.1.3 A 50mm thick layer of clean dry sand filling selected and supplied by the manufacturer/contractor, watered and consolidated to be laid under the floor.
- 2.3.1.4 The concrete to be a minimum of 20MPa but greater if needed to comply with the manufacturer/contractor's design.
- 2.3.1.5 The thickness of the concrete in the floor construction to be a minimum of 90mm.

- 2.3.1.6 Any bar or mesh reinforcement required to comply with the manufacturer/contractors design must be incorporated into the slab.
- 2.3.1.7 The surface to be finished in a screed not less than 30mm thick to suit the floor finish (vinyl tiles). Power floated finish will be allow, should the finished not be approved by the Principal Agent, a screed with a minimum thickness will have to be applied.
- 2.3.1.8 300 x 300 x 2,5mm semi-flexible reinforced vinyl floor tiles, or equal approved, laid to manufacturers specification in patterns to colour of the Project Manager.
- 2.3.1.9 The manufacturer/contractor to allow for any contraction and expansion joints as required.
- 2.3.1.10 Finish Floor Level must be a minimum of 170mm above concrete aprons/or channels.
- 2.3.1.11 1,5m wide Walkway surface bed to be constructed as above and finished off with a wood float finish. The surface bed to fall 35mm from the building to the edge of the walkway and a 30mm step to be provided at the threshold (ie 30mm step from the finished floor level in the classroom to the top of the finished level on the walkway).
- 2.3.1.12 Steps to be provided should the level of the walkway be more than 200mm above the surrounding ground level. Individual steps height should be maximum of 200mm and the width not less than 250mm.

2.3.2 TEMPORARY FLOOR CONSTRUCTION

- 2.3.2.1 Temporary floors to be constructed out of 19mm thick treated shutter board or similarly approved material, on an engineered designed galvanized steel structure. The under side of the floorboards must be treated with two coats of carbolineum, or an equally approved product. The construction method used, must be so that the structure can be removable, erectable and transportable to an alternative site.
- 2.3.2.2 The temporary floors to be provided with a support structure for the galvanized steel structure. Details of the support structure to be provided.
- 2.3.2.3 The area under the floor structure to be closed with a durable side wall material (Breathable allow For Ventilation). Vermin proof area under floor structure.

2.4 EXTERNAL AND INTERNAL WALLING

The wall construction method contemplated must allow for the dismantling, transportation and re-location on an alternative site, estimated not further than 100km. A re-location manual, detailing the dismantling and re-erection of the structure must be submitted with the tender.

2.4.1 WALLING

All external walling to comply with the thermal design as detailed below.

2.4.1.1 Interior Comfort Limit / Interior temperatures:

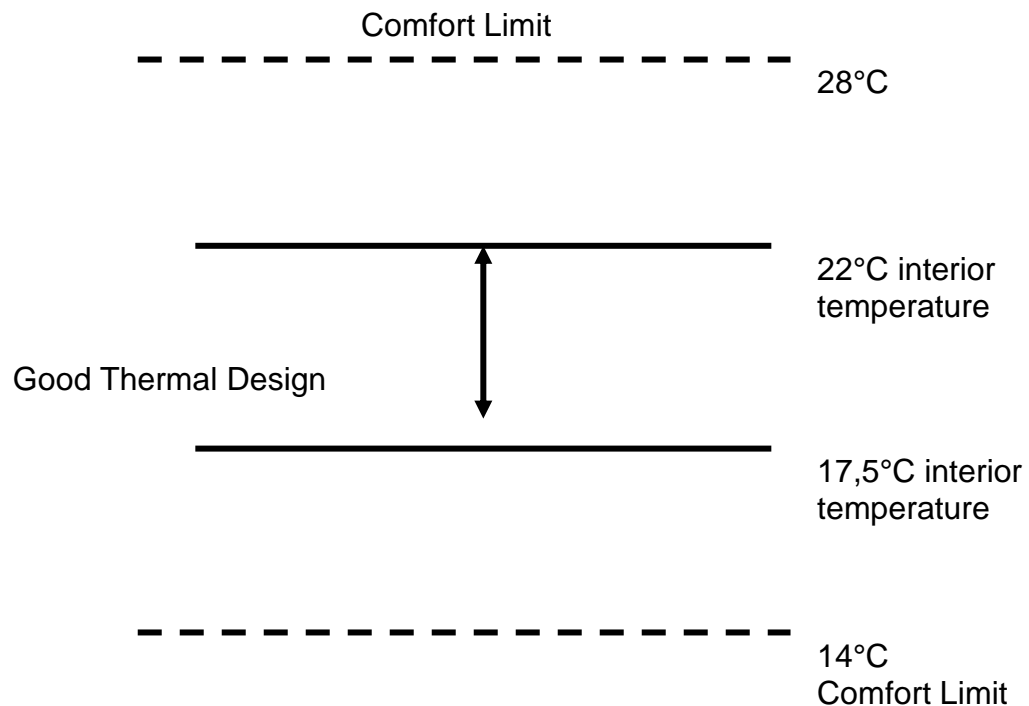

- C Value = effective heat storage capacity per square metre of building skin area (kJ/m²K)

Example for 1) Durban area – Hot humid
C value = 300

2) Winter rainfall area region (Cape)
C value = 500

3) Highveld region (Pretoria) and inland
C value = 800

Recommendation for Eastern Cape:

Coastal C value = 400
Inland Eastern Cape C value = 600

- 2.4.1.2 The external walls to be cladded in a weather proof, impact resistance material, consisting of; pre-painted fibre cement sheeting (shiplap profile), or a treated timber boarding, or a pre-painted metal sheeting and or an equivalent system subject to approval by the Principal Agent in conjunction with the relevant Government Stakeholders.
- 2.4.1.3 The external walling to contain suitable vapour barriers between the floor and the walling. At the wall plate level, the wall should be properly sealed. The anchoring system specified to secure the wall panels into position must be of a non corrosive material.
- 2.4.1.4 All internal walls to have a smooth finish, and be constructed out of a weatherproof durable impact resistant material. (Gypsum boarding is not an acceptable material)
- 2.4.1.5 The construction method used, must allow for the structure to be relocated at any given time.

2.4.2 External Doors

All external doors to be 44mm x 813 x 2032mm meranti framed ledged and braced doors formed of 44 x 220mm top and bottom rail, 22 x 100mm bracing rail and stiles, 22 x 69mm tongued grooved and V jointed one side boarding, twice countersink screwed at intersection with internal panels rebated and filled with 6mm Sapele veneered plywood or similar approved door.

All joints between rails and stiles to be of mortise and tenon construction.

All doors fitted with an approved durable door handle and a 3 level-lockset, three brass butt hinges, and rubber doorstop fixed to floor/weather bar.

2.4.3 Windows

Window areas are to comply with NBR requirements. Where steel windows are used, members must be constructed out of FX7 sections and be hot dipped galvanised. Other window types will be considered for approval. Tenderres to ensure that different metals are isolated with a neoprene strip.

It is recommended that three 889w x 854h mm (on the walkway side) and four 889w x 1248h mm (on the opposite side) are used per classroom, two 889 x 1248h mm for the Office and two 889w x 854h mm for the Store. It is further advised that an outwards opening pivot type window be used on the walkway side of the classrooms and offices. This is to ensure that no opening sections

open onto the walkway at a head height level.

All windows to be fully burglar proofed with an approved burglar bar system.

2.4.4 Dado Rail

All internal walls to have a dado rail of a minimum dimension of 19 x 100mm, fitted \pm 900mm above floor level (height to be adjusted to the chair height for primary or secondary schools). Dado rail to be manufactured from hardwood or an approved durable impact resistant material, twice angle rounded and finished with an acceptable finish. Dado rail to be secured to the walls with minimal holes into the wall surface.

2.5 **ROOF CONSTRUCTION AND COVERING**

Two types of roof constructions will be required; a) Conventional roof structures and b) Roof structures for areas with a high snow fall and hurricane winds.

2.5.1 **TYPE A - CONVENTIONAL ROOF CONSTRUCTION**

2.5.1.1 The construction of the roof can be conventional prefabricated timber trusses with bracings (to SABS 0163-1980), or a steel construction (to SABS 0162-1984). The design and erection to be approved by a Registered Engineer and a certificate of compliance issued on completion.

2.5.1.2 The roof pitches to be not less than 15° and the Live and Wind Loads to be in accordance with SABS0160-1989.

2.5.1.3 The roof covering must consist of 0.58mm Nominal thickness corrugated iron roofing sheets with silicone polyester top finish or colomet equal, colour "Approved by DRPW" to one side and standard grey backing coat to other side, etc., with 275g/m² galvanising to both sides with one and a half corrugation side lap including fixing to timber purlins at approximately 1,000mm centres

including all screws, bolts, washers, etc, strictly in accordance with manufacturer's specification. If the contractor wishes to use an alternative, he must supply the information with his tender for consideration

- 2.5.1.4 All capping, eaves closure, barge boarding etc to be included and comply with the specifications.
- 2.5.1.5 All roofs to have a 600mm eaves overhang, and 300mm verge overhang.
- 2.5.1.6 15 x 225 Fibre cement or other similar approved fascias to be fitted, painted to paint manufactures specifications. (See also notes to tenders)
- 2.5.1.7 The roofs to be fitted with 125 x 150 x 125mm x 0.80mm thick pre-painted sheet iron or other similar approved gutter with 75mm wide laps fixed to falls to fascia with brackets not exceeding 1000mm centres, including all ends, outlets, etc.
- 2.5.1.8 Pre-painted rainwater downpipe must be provided. Number off downpipes to be calculated in accordance with the rainfall average of the area, not exceeding 15m in length.
- 2.5.1.9 All roofs to have 38 x 228mm gangboarding along entire length of building if an attic is created.

2.5.2 TYPE B - ROOF IN AREAS WITH A HIGH SNOW FALL AND HURRICANE WINDS

- 2.5.2.1 Roofs to be constructed as described in 2.5.1, with the following changes.
- 2.5.2.2 The roof pitches to be not less than 35°.
- 2.5.2.3 In areas with a high snowfall, a 450mm wide 0.8mm thick pre-painted flat sheet, colour to match the roof sheets, to be securely fixed into position above the corrugations, to the bottom end purlin, over the gutter. This will ensure that the snow falls over the gutter and does not rest on the gutter.
- 2.5.2.4 The Registered Engineer must be informed that the area of the school is exposed to snowfalls and or hurricane winds. The design and erection of the roof structure must be amended accordingly by the Registered Engineer and a certificate of compliance issued on completion.
- 2.5.2.5 The roofs ties to be provided in order to ensure that the roof structure is correctly tied to the supports or alternatively to the slab as per the requirements to the Engineer.

2.6 **CEILINGS**

All classrooms, offices and stores to be fitted with ceilings. Ceilings could be an integrated system with the roof sheeting or a conventional ceiling construction.

- 2.6.1 6,4mm Gypsum board sheets with hardwood cover strips, continuous in one direction and cut in between in the other direction, between sheets and fixed to 38 x 50mm brandering at 400mm centres including additional brandering at outer edge of rooms and along joints of ceiling plates.

If the contractor wishes to use alternative, e.g. suspended ceilings, he must supply the information with his tender for consideration.

- 2.6.2 An approved painted cornice at junction of wall and ceilings must be provided.

- 2.6.3 All ceilings to be insulated with 50mm glass fibre blanket or similar approved.

- 2.6.4 Provide one trap door in conventional ceilings per block.

2.7 **FLOOR COVERING**

- 2.7.1 All floors to be finished with semi flexible vinyl floor tiles size 300 x 300 x 2.5mm thick (colour samples submitted to principal agent for approval) laid with an adhesive to pattern and two coats approved sealer to be applied prior to handover.

- 2.7.2 Skirting to be 19 x 69mm hardwood screwed to framework and finished with three coats polyurethane suede varnish all-round. If the contractor wishes to use an alternative, he must supply the information with his tender for consideration.

2.8 **PLASTERING**

- 2.8.1 All thresholds to be grano with reedings.

2.9 **ELECTRICAL INSTALLATION**

- 2.9.1.1 All fittings and accessories must be presented to and approved by the Departmental Representative or the Consulting Engineer prior to installation.

- 2.9.1.2 Fluorescent fittings are to be twin-tube, or as specified elsewhere, open-channel, fitted with electronic ballasts (Professional). The fittings are to be adequately secured with wood screws, screwed into timber. "Butterfly" screws will not be accepted. Timber supports to be provided between the steel beams, the fittings are not to be screwed to the suspended ceiling frame-work. The

contractor must allow for a typical classroom (6,9M x 7,4M) 6No. Luminaries mounted at ceiling height. For Offices, 2No. Luminaries mounted at ceiling height. For Store Areas, 1No. Luminaries mounted at ceiling height.

Approved 2 x 58watt open channel fluorescent fitting; ILM lighting – ILM/ATL/FMII/258 **OR ANY EQUAL OR OTHER APPROVED FITTING**

- 2.9.1.3 For the external lighting to the classrooms, 2 x PL9 fittings must be round, aluminium, deep base, with polycarbonate lens fitted with 3 screws. The lens must not discolour. The fitting must be fitted with 2 ballasts and be fitted complete with lamps. The contractor must allow for 1No. Luminaire

fitted externally adjacent to the classroom door. Where Classrooms are constructed in clusters, allowance must be made for 1No. Luminaire to be fitted to the gable ends of the blocks of classrooms and 1No. Luminaire fitted per pair of classrooms on the rear elevation. All external lighting is to be operated by a daylight photocell. The contractor must allow for 1 x photocell and 1 x contactor per 10 external light fittings. The Contractor is to ensure that all external fittings are adequately sealed to prevent ingress of insects and moisture. A minimum IP rating of IP65 required.

Approved 2 x PL9 fitting; Beacon Lighting - BL/RD -NB 2 X PL9W, **OR ANY EQUAL OR OTHER APPROVED FITTING**

- 2.9.1.4 Fluorescent tubes and lamps are to be of the highest quality. No inferior or "no-name" brands will be accepted. All fitting/s requested must be provided complete with tubes. Contractor must allow for Phillips or Osram lamps color White
- 2.9.1.5 Timber must be provided to secure fittings where necessary. Fittings must be mounted flush with the ceiling and cover-strips must be neatly cut to accommodate the fittings.
- 2.9.1.6 The single-lever light switches are to be equal or other approved to Crabtree type 2471, complete with steel cover-plates and steel screws. The contractor must allow for 1 x single lever switch complete with 50mm x 100mm box and white faceplate per classroom, Office and Store. The light switch is to be mounted next to the door and at 1400mm above floor level to the centre of the switch.
- 2.9.1.7 Socket outlets are to be equal or other approved to Crabtree type 6861 complete with steel cover-plates and steel screws. The contractor must allow for 1 x duo 16A socket outlet complete with 100mm x 100mm box and white faceplate per classroom. The socket outlet is to be mounted adjacent to the classroom blackboard and at 1200mm to the centre of the outlet box. In the office areas, 2No. Socket outlets must be allowed for mounted adjacent to the

desk position. The Store Areras will also require 1No. socket outlet mounted adjacent to the door.

- 2.9.1.8 All socket outlets, switches etc are to be fitted with steel cover plates and steel screws.
- 2.9.1.9 The new DB is to be custom-made, complete with door and "Swing-lever" door catch. Color: White. Allowance must be made for at least six (6) spare MCB spaces. The spares are to be fitted with blanks. The contractor must allow for 4 x 20mm spare conduits to be taken into the roof space. The circuit breakers are to be labeled with engraved Perspex/PVC type labels, fastened by means of screws. In addition to the numerals, labels shall be mounted under each MCB, identifying the circuits they control. A typed legend card shall be placed in the holder provided and shall indicate the type and location, e.g. No.1. ..Main, No.2.....Lights - Drawing office etc. An engraved danger sign is to be screwed to the face-plate. An engraved label is to be screwed to the outside of the door, identifying the DB as "SDB-B" etc. The Contractor must allow for one DB for each classroom blocks or where a classroom is constructed as a single unit at any particular site.
- 2.9.1.10 The new supply cable trench must be a minimum depth of 600mm X 300mm wide and cleared of all injurious material with a 75mm bed of sand to follow. The new cable must be installed on the sand bed. A sand backfill of at least 100mm is required above the cable. Danger tape must be laid at this level. The trench is to be properly filled and compacted with backfill free of any injurious materials. If a dedicated earth conductor is installed, the dedicated earth conductor must be secured to the cable by means of cable ties at intervals not exceeding 1m. The trench must be inspected by the Departmental Representative prior to the installation of the cable. Where the trench crosses roadways, concreted/paved areas, PVC sleeves must be installed, and the road concreted/paved areas must be 'made good' to the satisfaction of the Departmental Representative.
- 2.9.1.11 Cables must be drawn through 'galvanized kick-pipes' for all surface entry/exits to buildings. 'Kick-pipes' to be neatly saddled at intervals not exceeding 1m.
- 2.9.1.12 The installation is to be properly tested and commissioned on completion and an 'original' Certificate of Compliance issued for the installation.
- 2.9.1.13 All work to be strictly in accordance with SANSI 0142, Departmental Standards and Norms (General Technical Specification-Provincial Administration/Quality Specification for Electrical Installations) and Municipal by-laws. Departmental documents are available for scrutiny at the offices of Department of Public Works, Regional Office, Port Elizabeth.
- 2.9.1.14 The Contractor must ensure that the premises are left in a clean, neat and tidy condition on completion of the installation. All expended materials no longer

required must be removed from site unless specifically requested by the Departmental Representative not to do so.

2.9.1.15 On completion of the contract, the successful contractor shall notify the Department at least 7 days in advance before delivery will be taken.

2.9.1.16 The successful bidder shall not take any instructions from anyone other than the Departmental Representative or Consulting Engineers. No

variation/s must be entertained by the Contractor without a written Site Instruction and approved Variation Order from the Departmental Representative.

2.9.1.17 Minimum standard for all materials used must conform to S.A.N.S. standards and must bear the S.A.N.S. mark.

2.9.1.18 Expended hazardous materials e.g. Fluorescent tubes, etc must be removed from site and disposed of in the legally required manner as prescribed by the Occupational Health and Safety Act.

2.9.1.19 The use of 'twin & earth' will NOT be permitted. 'Surfix' will be permissible with the approval from the Departmental Representative or Consulting Engineer.

2.9.1.20 Wire sizes: Lighting circuit -1,5mm² PVC conductor + 2,5mm² earth (with 10A.MCB)
Plug circuit - 2,5mm² PVC conductor + 2,5mm² earth (with 20A MCB)

2.9.1.21 The use of PVC flexible hose as a substitute for PVC or any other type/s of conduit will **not** be permitted. However, in situations where the use of regular conduit is either impractical/impossible, written permission **must** be obtained from the Departmental Representative/Consulting Engineer prior to the installation thereof.

2.9.1.22 Should it be necessary to utilize the contingency sum, a detailed breakdown of costs must be submitted to the Department. Written approval from the Departmental Representative must be obtained before such sum is utilized.

2.9.1.23 With all 3 phase supply installations, it is the responsibility of the Contractor to ensure that the loading is 'balanced' over the 3 phases.

2.9.1.24 Note: The structure is to be protected against lightning, a certificate of compliance for a lightning protection system must be issued upon installation of lightning protection system.

2.9.2 ELECTRICAL SUMMARY -The contractor must allow the following for each classroom:

2.9.2.1 6No. Luminaries mounted at ceiling height. Approved 2 x 58watt open channel fluorescent fitting; ILM lighting – ILM/ATL/FMII/258 **OR ANY EQUAL OR OTHER APPROVED FITTING**

1No. one way, single lever light switch located adjacent to the door.

1No. External Luminaire mounted outside the classroom door. 1No. Luminaire at each gable end. (Where classrooms are constructed more than 2, an additional light fitting per pair of classrooms is to be allowed)

Approved 2 x PL9 fitting; Beacon Lighting - BL/RD -NB 2 X PL9W, **OR ANY EQUAL OR OTHER APPROVED FITTING**

1No. 16A Duo socket outlet mounted adjacent to the blackboards

2.9.3 The contractor must allow the following for each office area:

2.9.3.1 2No. Luminaries mounted at ceiling height. Approved 2 x 58watt open channel fluorescent fitting; ILM lighting – ILM/ATL/FMII/258 **OR ANY EQUAL OR OTHER APPROVED FITTING**

2.9.3.2 1No. one way, single lever light switch located adjacent to the door.

2.9.3.3 2No. 16A Duo socket outlet mounted within the office space adjacent to the desk position.

2.9.4 The contractor must allow the following for each store area:

2.9.4.1 1No. Luminaries mounted at ceiling height. Approved 2 x 58watt open channel fluorescent fitting; ILM lighting – ILM/ATL/FMII/258 **OR ANY EQUAL OR OTHER APPROVED FITTING**

2.9.4.2 1No. one way, single lever light switch located adjacent to the door.

2.9.4.3 1No. 16A Duo socket outlet mounted within the store area adjacent to the door.

2.10 **GLAZING**

All glazing to be in accordance with, SANS 10 400 Part N, as affective from the 1st March 2006.

2.11 **PAINTING**

All surfaces that require painting to be painted in accordance with the paint manufactures specifications.

2.12 **FINISHES**

2.12.1 Writing Boards

Supply a set of two standard Vitreous enamel magnetic chalkboards with aluminium chalkrail including setting up and fixing to walls complete and securing bottom of each board with two fixing brackets in accordance with the manufacturer's instructions, size 4,800 x 1,140 mm high overall. Writing boards to be secured to the walls with minimal holes into the wall surface, chalk rail to be not more than 900mm above FFL.

2.12.2 Pinning boards

Supply and fit 12mm thick x 1,2m high softboard, or similarly approved pinning board across the full width of the rear of each classroom. Pinning boards to have a 44 x 22mm rebated hardwood surround, finished with three coats polyurethane suede varnish. Pinning boards to be secured to the walls with minimal holes into the wall surface.

2.12.3 Fire extinguisher

Supply and fit one 4,5kg CO² fire extinguisher per room, fixed to a hardwood backing-board, 1 200mm above FFL, securely fixed to the wall.

2.12.4 Long-arms

Should windows be of pivot type, supply and fit one 600mm long-arm per classroom. Fitted behind the door with two brackets.

2.12.5 Cupboards

Supply and fit one pre-painted steel stationary cabinet size 900 x 450 x 1,800mm, painted in a light approved paint colour, to each classroom and office. Screw cupboard to the wall.

2.12.9 Partitioning Wall

2.12.9.1 Partitioning wall of the approved prefabricated material as per manufacturer's specification at 1.8m high to be used to configure office accommodation.

2.12.9.2 Partitioning wall of the approved prefabricated material as per manufacturer's specification at ceiling height

Part 6: Site Information

C4 Site Information

**C4: SITE INFORMATION - JBCC 2000 PRINCIPAL BUILDING
AGREEMENT (Edition 4.1 of March 2005)**

Project title:	PREFABRICATED STRUCTURE RELIEF PROGRAMME: SUPPLY AND ERECT TWO CLASSROOM BLOCK AT AMAZIZI SENIOR SECONDARY SCHOOL
Bid No:	2022/07/065

C4 Site Information

GPS CO-ORDINATES

GIS_Longitude	GIS_Latitude
27,086695	-33,387198

1. GROUND CONDITIONS

Geotech information not available. This is an existing site.

2. UNDERGROUND SERVICES

There are unidentifiable underground services traversing the area of works, care would need to be taken during excavations.

3. ADJACENT BUILDINGS

No adjacent buildings could be affected by the construction. No particular precautions have been identified by the Engineer for the protection of this structure.

4. ENVIRONMENTAL ISSUES

None

C5

Drawings

C5.1: DRAWINGS

Project title:	PREFABRICATED STRUCTURE RELIEF PROGRAMME: SUPPLY AND ERECT TWO CLASSROOM BLOCK AT AMAZIZI SENIOR SECONDARY SCHOOL
Bid No:	2022/07/065

Drawing tile	Drawing number	Print date	Rev No.
Prefabricated classroom: 2 x classroom		09/11/2021	
Plan, Section and Elevation		09/11/2021	
Typical supplier details examples		09/11/2021	
Typical supplier details examples		09/11/2021	

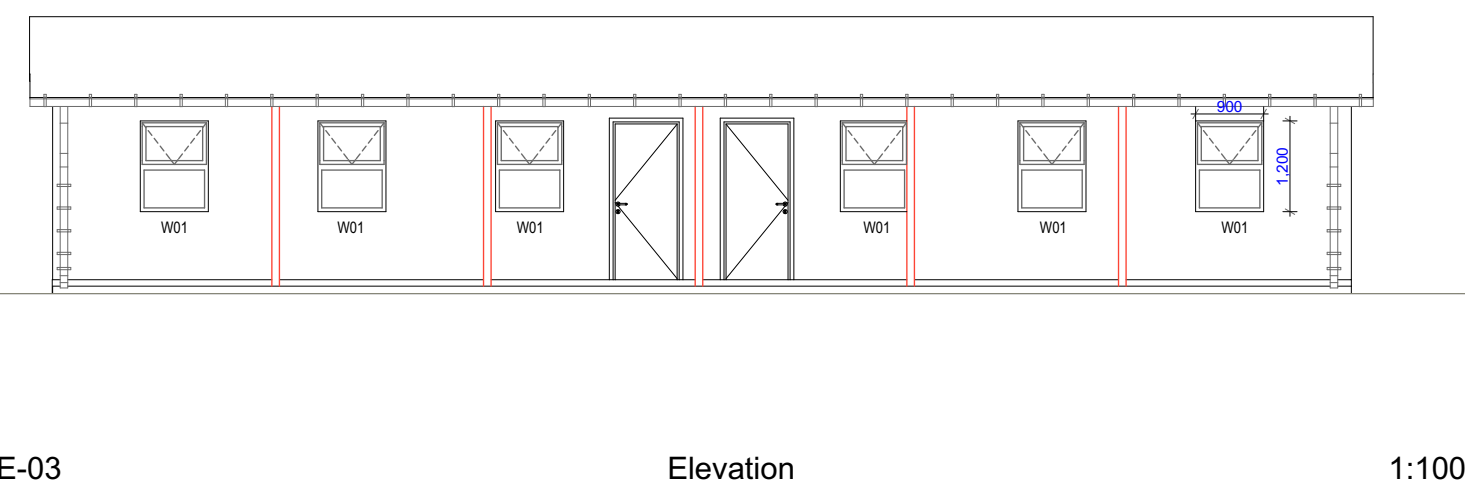
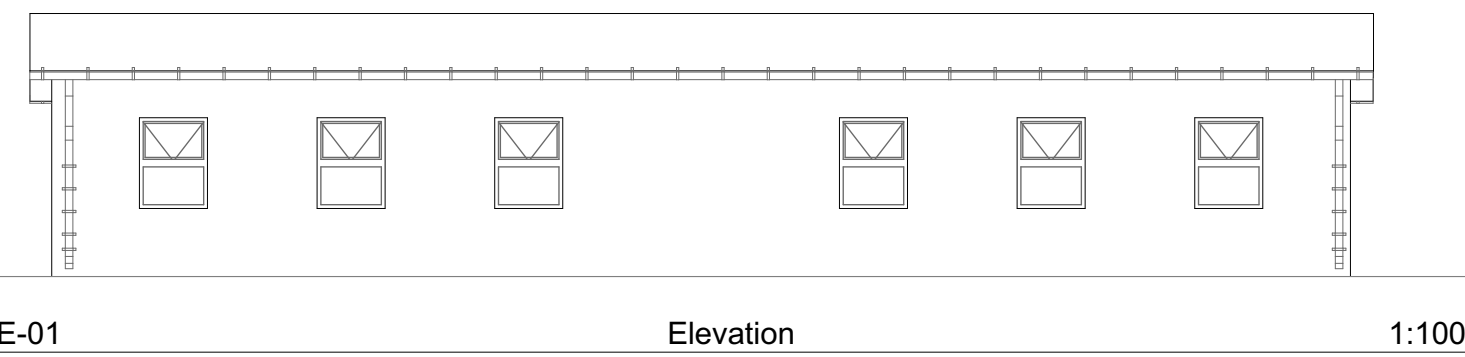
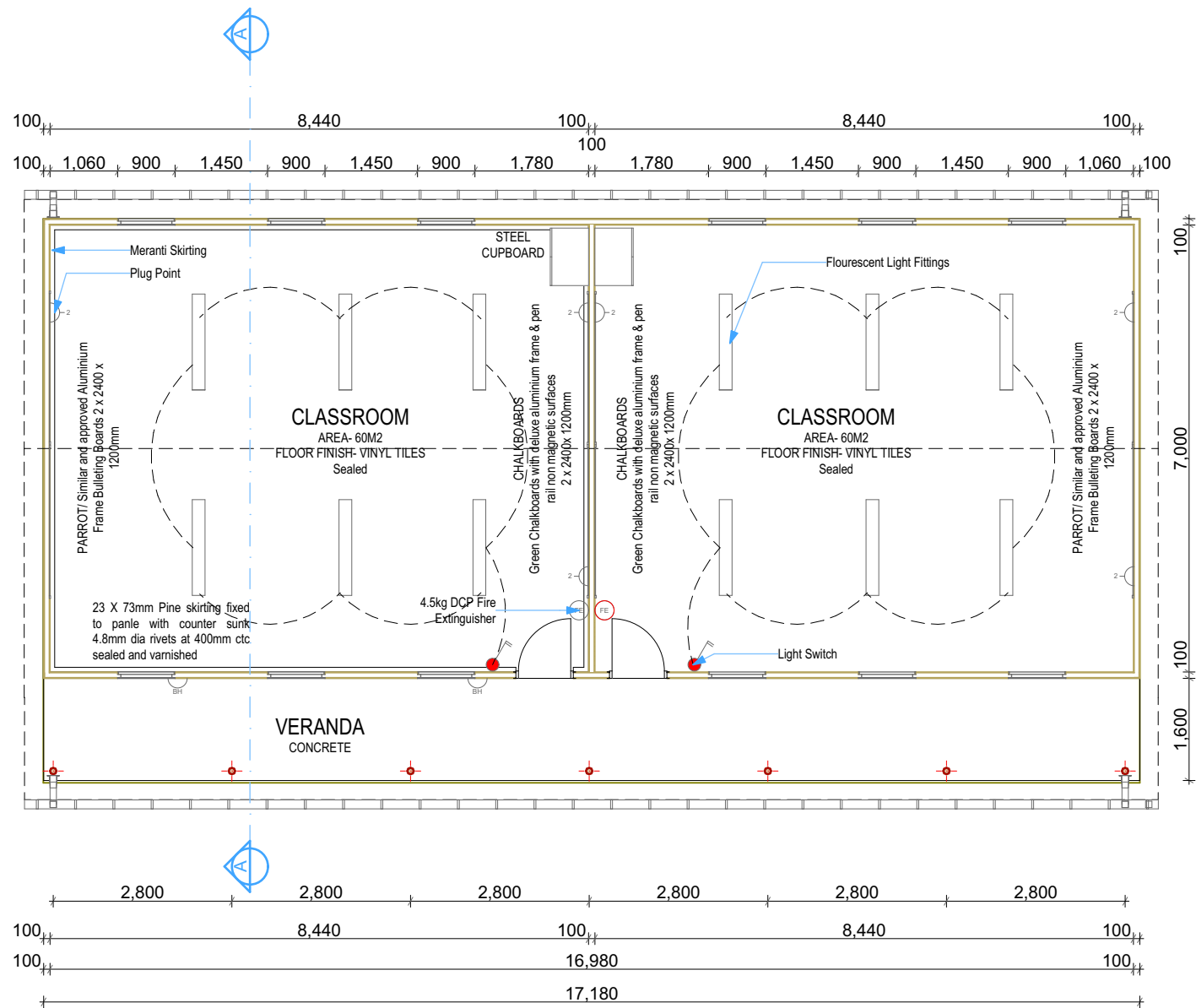

PREFABRICATED CLASSROOMS
 Prefabricated structure complete including prefabricated walling, doors, windows minimum of 10% window to floor area light ratio, ceilings, roofs, Electrical and finishes. Structure to conform to the NHBRC and SANS standards.
 Construction of prefabricated structure for classrooms (60m² per Classroom) building size 16,030mm x 9,304mm wide x 3,000mm high overall, building width is inclusive of verandah 1,600mm wide with verandah poles encased in concrete. Prefabricated structure complete including prefabricated walling, doors, windows, ceilings, roofs, Electrical and finishes. Structure to conform to the NHBRC and SANS standards.
 Each classroom must have a pinning board size 4800 x 1300mm high and chalk board size 4800 x 1300mm high. The structures must also include barge boards, fascia boards, gutters and downpipes.
WALLS
 Fluted/flat Panels are used for wall construction. All panels are tung and groove. Panels of 0.5mm coloured chromadek steel sheeting with Expanded polystyrene. Thickness of 40mm/ 75mm/ 100mm wall panel. The R Values of the walls, roof ie building elements for thermal comfort.
ROOF and CEILING
 Ceilings for building < 3.5m wide
 40mm/ 50mm polyurethane panel (refer to wall panels specification above);
 Minimum floor to ceiling height 2.400mm high as indicated on floor layouts
 Roof Fixing designs to be looked at and signed off. (consider that roofs should not be blown off) • Roof sheeting must be positive fixed on each IBR profile along the ridge and gutter purlin. • Flashing or barge boards must be fully fixed to resist wind suction. • Roof thickness is 60mm (as per supplier detail) • Provide R Value and thickness of insulation • Provide specific treatment of the roof covering to withstand coastal conditions.
FLOORS
Specification
 2.5mm thick PVC Tiles on concrete floor.
Finish/ Sealer
 Floorworx matt sealer/ similar and approved :
 Floorworx Silk Matt Sealer is a durable matt finish water-based acrylic emulsion floor coating that carries the SANS 1042 mark and is suitable for use in high traffic areas.
Properties
 • Coverage rate of 20m² per litre
 • Self-shining
 • Due to its acrylic properties, Floorworx Silk Matt Sealer does not collect dirt like wax polishes
 • Slip-resistant
 • Excellent wear resistance
 • As easy to remove as it is to apply
 • Ideal protective coating for painted floors
 • Water-based applicators can be cleaned with clean tap water
WINDOWS
 • Natural anodised 25 micron aluminium frame;
 • Top hung frames fitted with 4mm clear float glass for all windows except in toilets and ablutions where obscure float glass is used;
 • Standard sizes throughout 900mm x 1200mm or 1200mm x 900mm (allow for 10% of floor area)
 • Burglar proofing over all opening windows;
 • Blinds and Flyscreens (provided as an optional when required)
DOORS and SECURITY GATES
External & Internal
 • 40mm thick door panel cut from standard Kwikspace PU wall panel;
 • Standard size of 2032mm x 813mm;
 • Each door framed with 0.5mm pre-painted galvanised capping riveted to door panel;
 • Natural anodised aluminium rebated door frame including rubber buffers and heavy duty aluminium hinges;
 • Pre-painted galvanised drip rail to doors opening outwards;
 • External locks are five lever Dorma locks complete with stainless steel striker plate and two keys; Chrome plated handles or Equivalent.
GATES - Galvanised Metal Security Gates to all openings
RAINWATER GOODS
 Seamless Aluminium Gutters and downpipe/ PVC Gutters and downpipes to Architect's approval
FURNITURES and FITTINGS
 Steel Cupboard
ELECTRICAL
 Allow for Euro Plugs All electrical cables (wire ways to plugs and switches) to be encased within the panel /structure. Light fittings can be surface mounted. Electrical elements as per Electrical specifications.
 4 X Plug points per classroom
 1 x Light Switch
 Fluorescent Lights as per Engineer Specification and approval
FIRE FIGHTING
 1 X 4.5KG DCP Fire Extinguisher per Classroom
EXTERNAL WORKS
 900mm Wide V channels Around the Building to Engineer's Detail.
 Rainwater Harvesting Tanks on stand constructed of Brick work and concrete slab .
APPROVALS AND COMPLIANCE
 All the alternative building technology buildings are design build therefore the contractor must employ a competent qualified design team for the design, construction supervision and commissioning of the buildings. The Modular Structures Specifications for Design, Manufacture, Supply, Deliver and Erect Prefabricated Structures attached to these Bills must be applied by the design team.
 As per tender documents the Contractor must provide :-
 • compaction certificate for density.
 • concrete compressive strength certificate.
 • structural walling certificates.
 • a roof covering certificate.
 • a certificate of compliance for electrical installation.
 • a lighting protection certificate where applicable.
 • a commission certificate for the entire building; it must also confirm the life expectancy of the building which be not less than 10 years.
 It remains the responsibility of the Contractor's / Supplier's Engineer to provide all certificates of compliance including the structural integrity certificates and the accompanying quality certificates of compliance for the materials used construction and assembly of the classrooms.
 Successful contractor must provide the principal agent with shop drawings and foundation designs before commencing with works on site. The contractor must resume with the works only after the client / principal agent has approved the design of the buildings

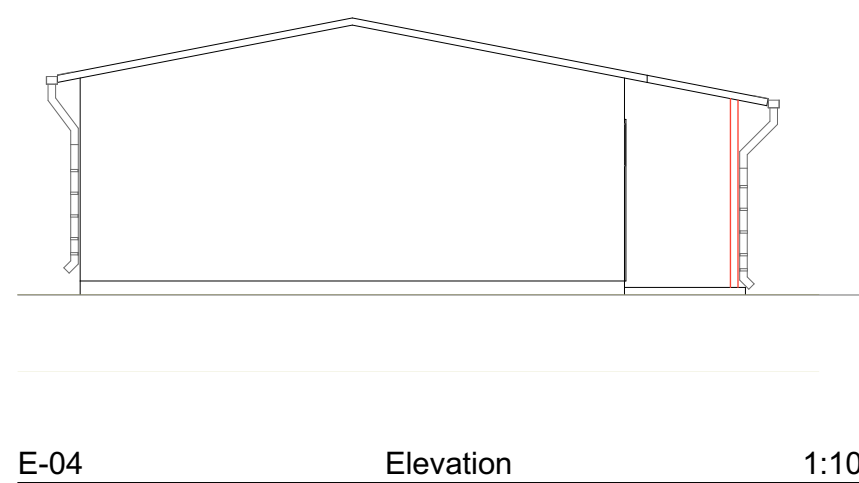
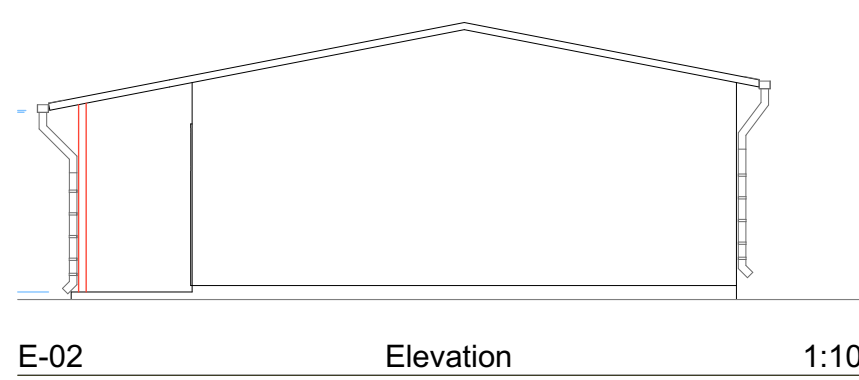

REFERENCE / LOCALITY PLAN			
NOTES:			
THE USE OF TRADE NAMES ON THIS DRAWING SIMPLY SERVES TO INDICATE A STANDARD ACCEPTABLE TO THE DEPARTMENT, ANY OTHER BRAND MAY BE USED WITH THE PRIOR WRITTEN APPROVAL OF THE PROJECT LEADER.			
THE CONTRACTOR MUST WORK FROM FIGURED DIMENSIONS ONLY. CHECK ALL DIMENSIONS AND LEVELS ON SITE BEFORE COMMENCING ANY WORK. ALL DRAWINGS TO BE READ IN CONJUNCTION WITH DETAILS, SCHEDULES, DRAINAGE DRAWINGS, INTERNAL ELEVATIONS, ENGINEERS AND OTHER SPECIALIST'S DRAWINGS.			
REFER CONFLICTING INFORMATION TO THE ARCHITECT AND OTHER RESPONSIBLE CONSULTANTS THE DESIGN ON THIS DRAWING IS THE PROPERTY OF THE PROVINCIAL GOVERNMENT, WESTERN CAPE. BRANCH WORKS AND COPY RIGHT IS RESERVED			
REVISIONS			
REV.	DESCRIPTION	DATE	BY
ORGANISATION/ DEPARTMENT			
 Province of the EASTERN CAPE EDUCATION Department of Education Steve Tshwete Building, Zone 6 Private Bag X0032 Zwelitsha Eastern Cape			
SCHOOL DETAILS			
SCHOOL NAME			
PREFABRICATED CLASSROOM : 2 x CLASSROOM			
BMS NUMBER			
(EMIS NUMBER)			
SCHOOL ADDRESS (NAME OF SCHOOL AND ADDRESS)			
COORDINATES XXXXXXXXXXXXXX			
LAND VERIFICATION/CONFIRMATION			
PROJECT TITLE			
PREFABRICATED CLASSROOMS			
APPROVALS/ SIGN OFF			
PROGRAM MANAGER (DOE)	DATE	SIGN	
PROJECT LEADER	DATE	SIGN	
SCHOOL GOVERNING BODY	DATE	SIGN	
SCHOOL PRINCIPAL	DATE	SIGN	
DRAWING TITLE			
PREFABRICATED CLASSROOM : 2 x CLASSROOM			
BLOCK ON CONCRETE FLOOR SLAB			
PLANNING	DELIVERY		
CAPITAL	MAINTENANCE		
DATE	PRINT DATE	DRAWN	CHECKED
November 2021	8/11/2021	SNK	RBAM
PROJECT FILE NO.			REV NO
DRAWING NO.	SCALE	PAPER SIZE	
	1:100, 1:200	A1	

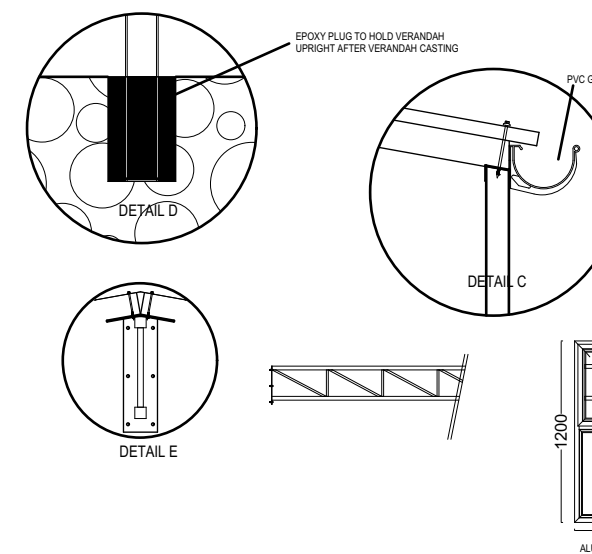
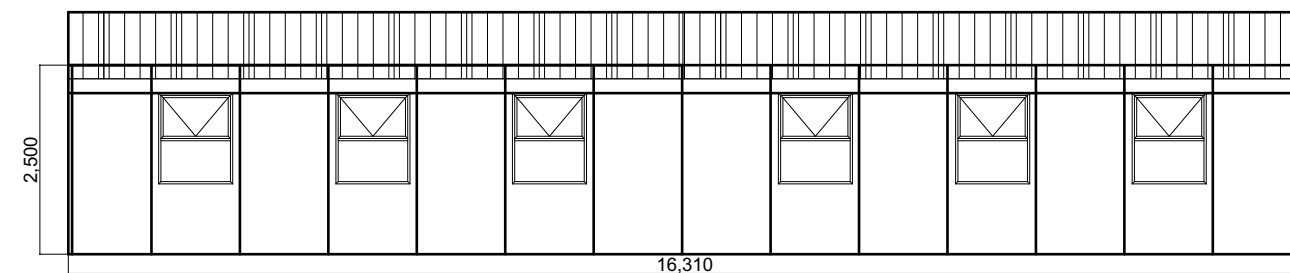
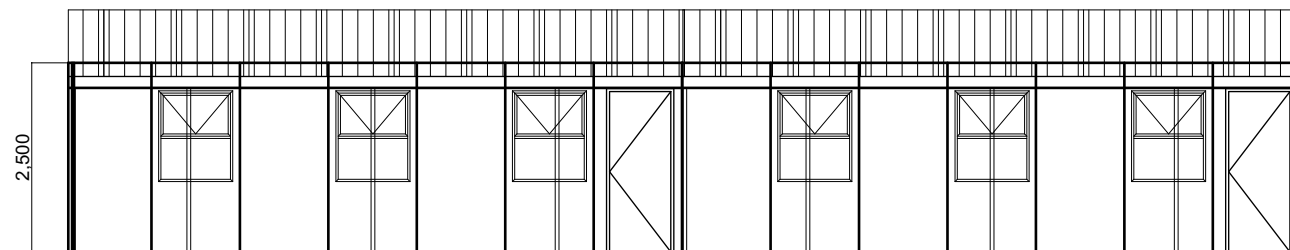
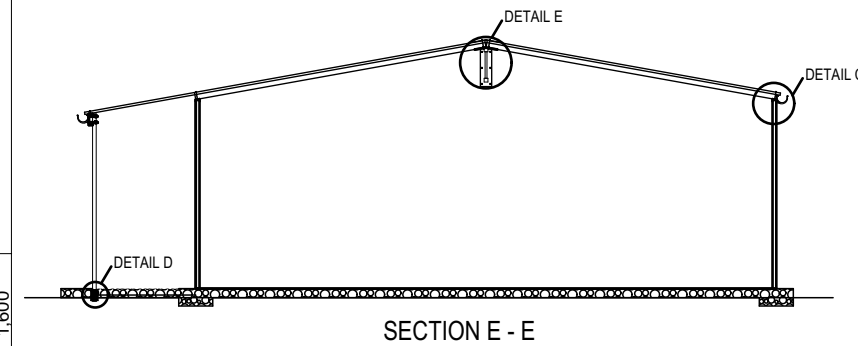
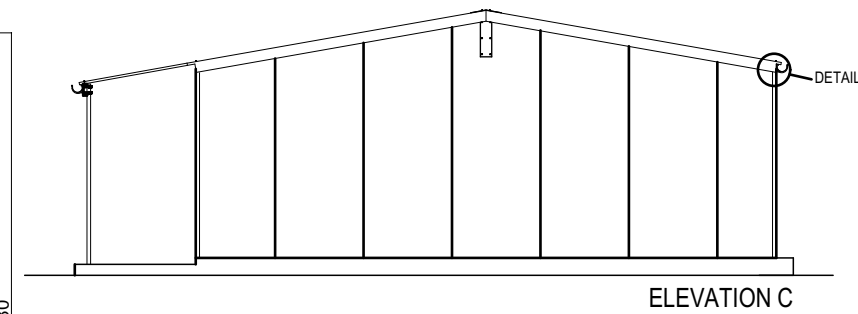
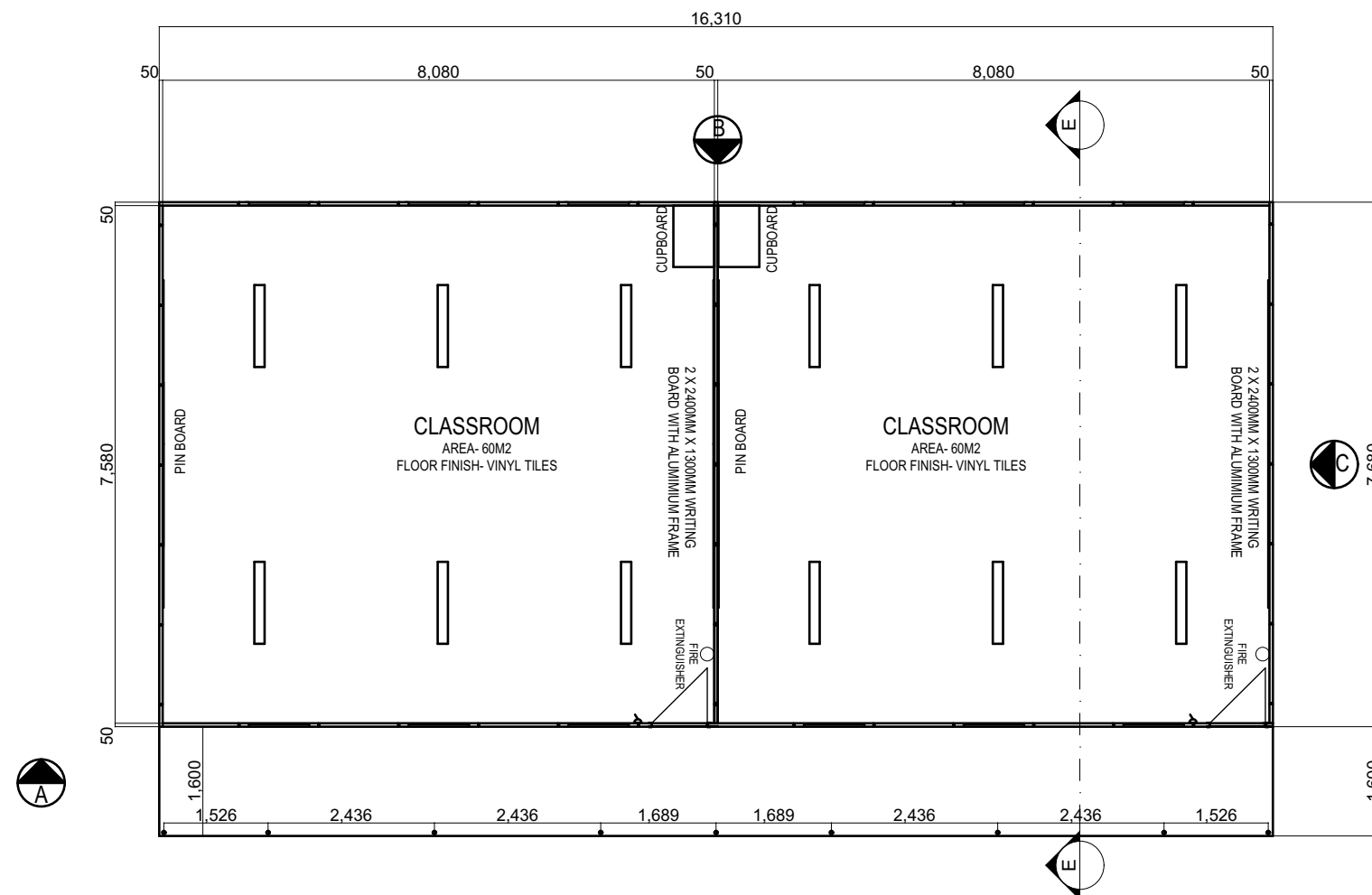

REFERENCE / LOCALITY PLAN

NOTES:
THE USE OF TRADE NAMES ON THIS DRAWING SIMPLY SERVES TO INDICATE A STANDARD ACCEPTABLE TO THE DEPARTMENT, ANY OTHER BRAND MAY BE USED WITH THE PRIOR WRITTEN APPROVAL OF THE PROJECT LEADER.

THE CONTRACTOR MUST WORK FROM FIGURED DIMENSIONS ONLY. CHECK ALL DIMENSIONS AND LEVELS ON SITE BEFORE COMMENCING ANY WORK. ALL DRAWINGS TO BE READ IN CONJUNCTION WITH DETAILS, SCHEDULES, DRAINAGE DRAWINGS, INTERNAL ELEVATIONS, ENGINEERS AND OTHER SPECIALIST'S DRAWINGS.

REFER CONFLICTING INFORMATION TO THE ARCHITECT AND OTHER RESPONSIBLE CONSULTANTS
THE DESIGN ON THIS DRAWING IS THE PROPERTY OF THE PROVINCIAL GOVERNMENT, WESTERN CAPE. BRANCH WORKS AND COPY RIGHT IS RESERVED

REVISIONS

REV.	DESCRIPTION	DATE	BY

ORGANISATION/ DEPARTMENT

Province of the
EASTERN CAPE
EDUCATION
Department of Education
Steve Tshwete Building, Zone 6
Private Bag X0032
Zwelitsha
Eastern Cape

SCHOOL DETAILS

SCHOOL NAME
2 X CLASSROOM PREFABRICATED CLASSROOM
ON CONCRETE FLOOR SLAB
(EMIS NUMBER)

SCHOOL ADDRESS
(NAME OF SCHOOL AND ADDRESS)

COORDINATES
XXXXXXXXXXXXXX

LAND VERIFICATION/CONFIRMATION

PROJECT TITLE

PREFABRICATED CLASSROOMS

APPROVALS/ SIGN OFF

PROGRAM MANAGER (DOE)	DATE	SIGN
PROJECT LEADER	DATE	SIGN
SCHOOL GOVERNING BODY	DATE	SIGN
SCHOOL PRINCIPAL	DATE	SIGN

DRAWING TITLE

2 X CLASSROOM PREFABRICATED CLASSROOM
ON CONCRETE FLOOR SLAB

PLANNING	DELIVERY	
CAPITAL	MAINTENANCE	
DATE	PRINT DATE	DRAWN
November 2021	8/11/2021	SNK
PROJECT FILE NO.		CHECKED
		RBAM
		REV NO
DRAWING NO.	SCALE	PAPER SIZE
	1:100	A1

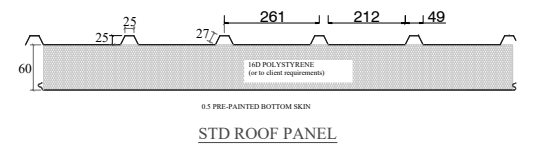
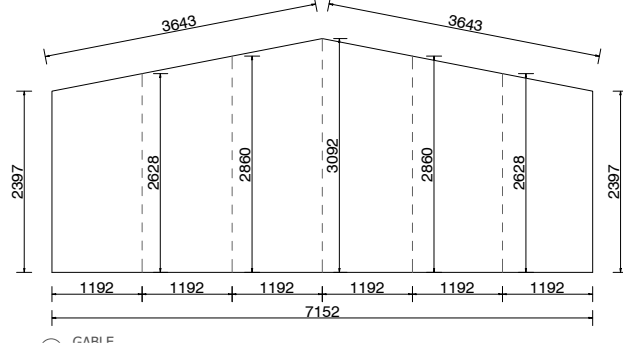
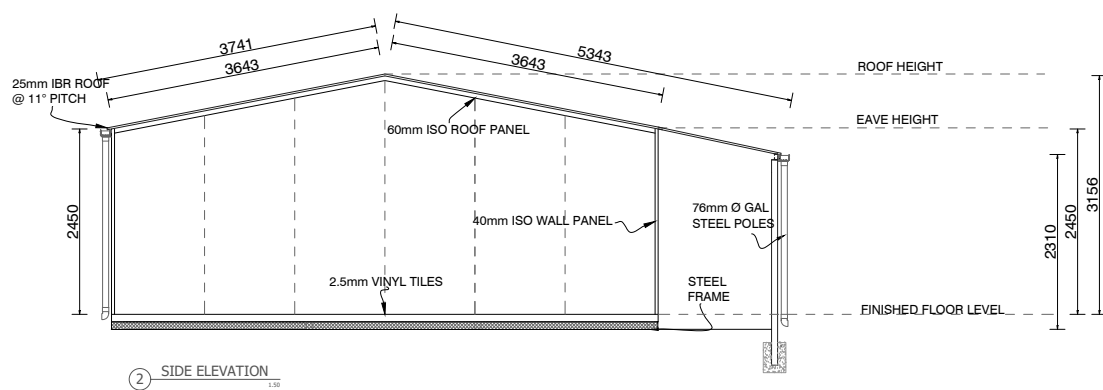
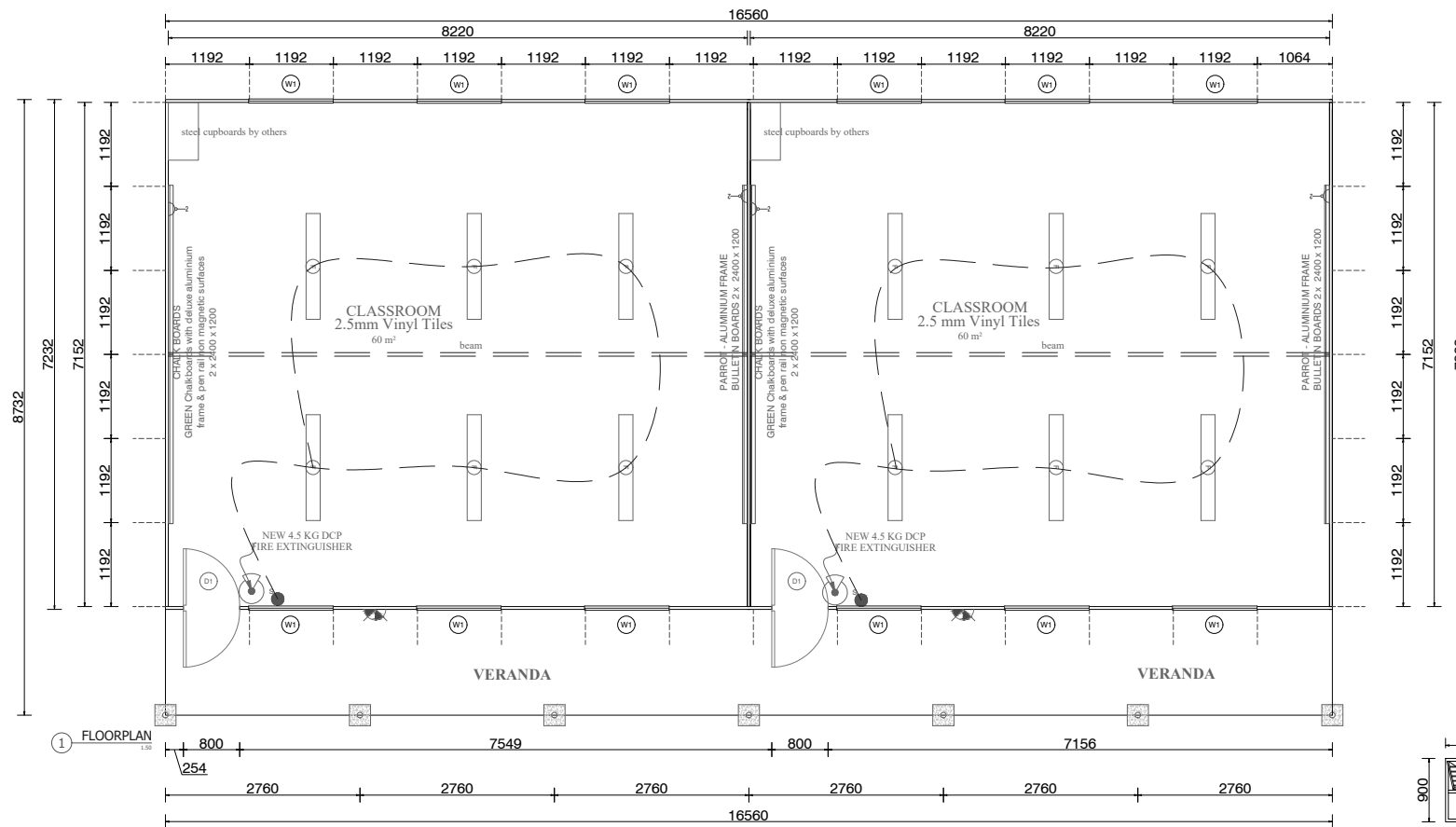

THICKNESS OF FIRE RETARDANT POLYSTYRENE CORE: 40mm - 50mm (16D) VARIES 50mm - 200mm (16D)

0.5 or 0.58 PRE-PAINTED GALVAL STEEL BONDED TO POLYSTYRENE WITH 2-PART POLYURETHANE SEALANT

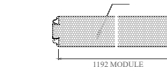

STD PANEL DETAIL

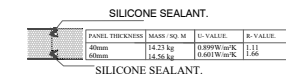

PANEL TO PANEL INTERLOCK

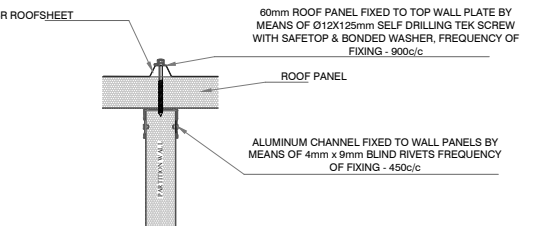

INTERNAL PARTITION WALL TO ROOF FIXING DETAIL

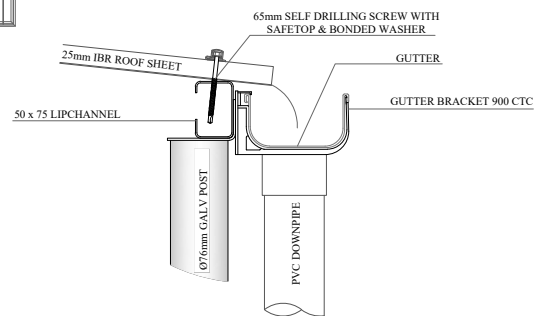

GALV. LIPCHANNEL FIXED TO GALV. POST BRACKET BY MEANS OF M8 x 25 GALV. BOLT AND NUT.

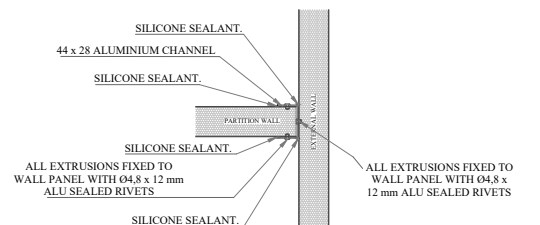

G. INTERNAL PARTITION WALL TO EXTERNAL WALL FIXING DETAIL

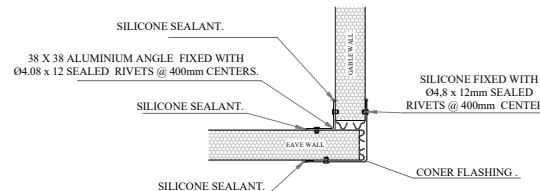

WALL TO WALL OUTSIDE CORNER FIXING DETAIL:

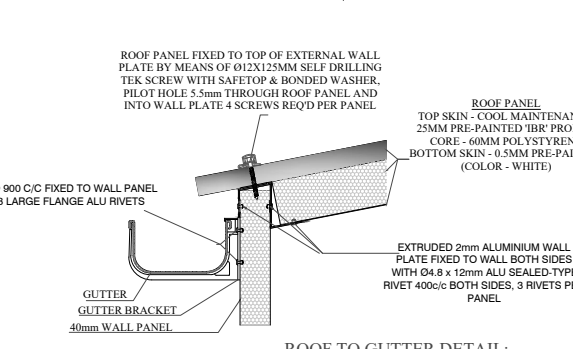
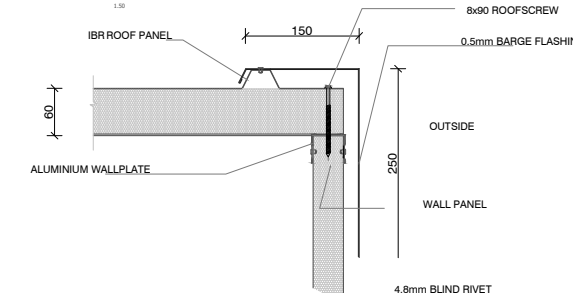

ROOF TO GUTTER DETAIL:

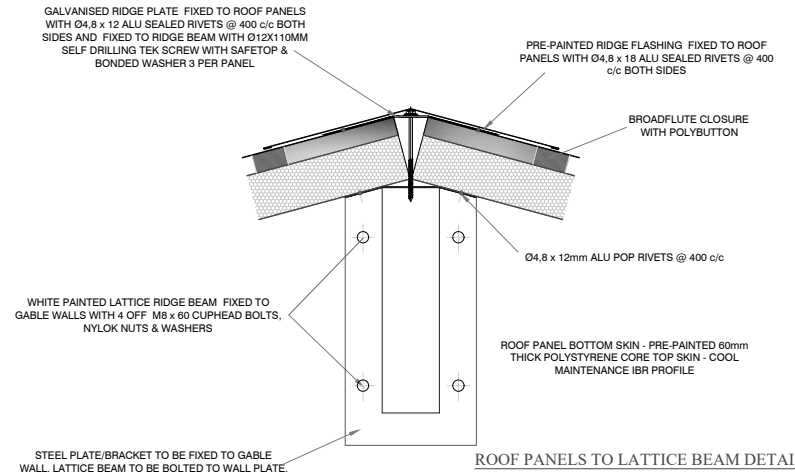

ROOF PANELS TO LATTICE BEAM DETAIL

REFERENCE / LOCALITY PLAN

NOTES:
THE USE OF TRADE NAMES ON THIS DRAWING SIMPLY SERVES TO INDICATE A STANDARD ACCEPTABLE TO THE DEPARTMENT, ANY OTHER BRAND MAY BE USED WITH THE PRIOR WRITTEN APPROVAL OF THE PROJECT LEADER.

THE CONTRACTOR MUST WORK FROM FIGURED DIMENSIONS ONLY. CHECK ALL DIMENSIONS AND LEVELS ON SITE BEFORE COMMENCING ANY WORK. ALL DRAWINGS TO BE READ IN CONJUNCTION WITH DETAILS, SCHEDULES, DRAINAGE DRAWINGS, INTERNAL ELEVATIONS, ENGINEERS AND OTHER SPECIALIST'S DRAWINGS.

REFER CONFLICTING INFORMATION TO THE ARCHITECT AND OTHER RESPONSIBLE CONSULTANTS
THE DESIGN ON THIS DRAWING IS THE PROPERTY OF THE PROVINCIAL GOVERNMENT, WESTERN CAPE, BRANCH WORKS AND COPY RIGHT IS RESERVED

REVISIONS

REV.	DESCRIPTION	DATE	BY

ORGANISATION/ DEPARTMENT

Province of the
EASTERN CAPE
EDUCATION
Department of Education
Steve Tshwete Building, Zone 6
Private Bag X0032
Zwelitsha
Eastern Cape

SCHOOL DETAILS

SCHOOL NAME
TYPICAL SUPPLIER DETAILS EXAMPLES
EMIS NUMBER
(EMIS NUMBER)
SCHOOL ADDRESS
(NAME OF SCHOOL AND ADDRESS)

COORDINATES

XXXXXXXXXXXXXX

LAND VERIFICATION/CONFIRMATION

PROJECT TITLE

PREFABRICATED CLASSROOMS

APPROVALS/ SIGN OFF

PROGRAM MANAGER (DOE)	DATE	SIGN
PROJECT LEADER	DATE	SIGN
SCHOOL GOVERNING BODY	DATE	SIGN
SCHOOL PRINCIPAL	DATE	SIGN

DRAWING TITLE

TYPICAL SUPPLIER DETAILS EXAMPLES

PLANNING	DELIVERY
CAPITAL	MAINTENANCE
DATE	PRINT DATE
November 2021	9/11/2021
PROJECT FILE NO.	DRAWN
	SKK
	CHECKED
	SBAM
	REV NO
DRAWING NO.	SCALE
	1:100
	PAPER SIZE
	A1

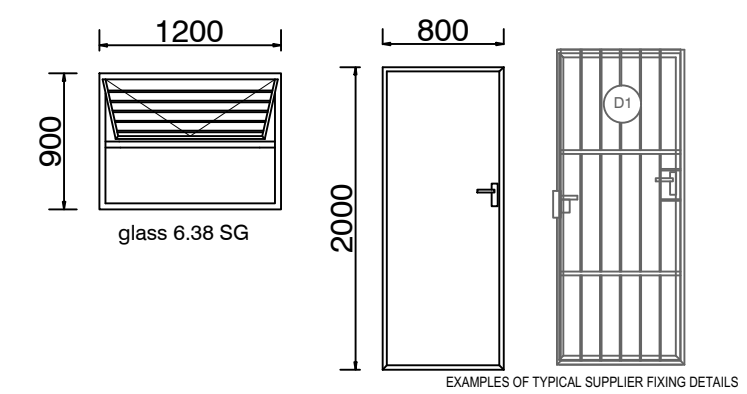
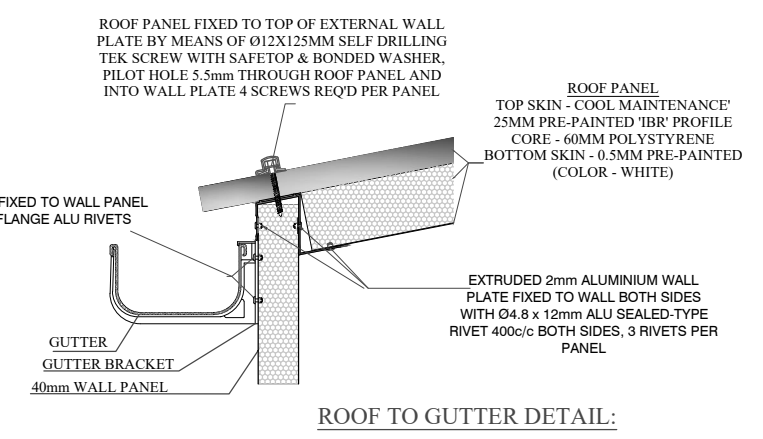
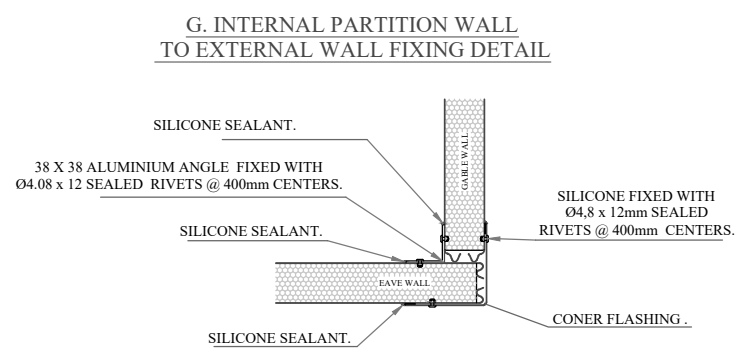
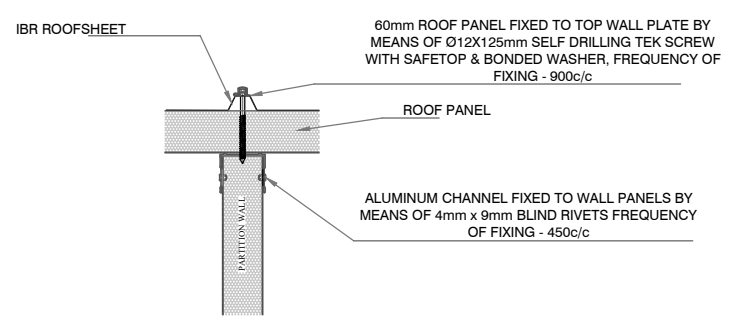
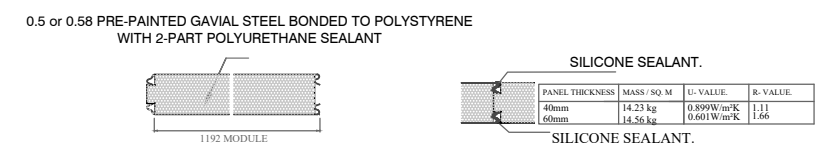
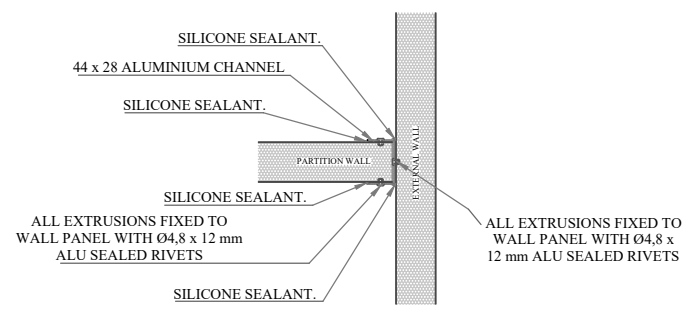
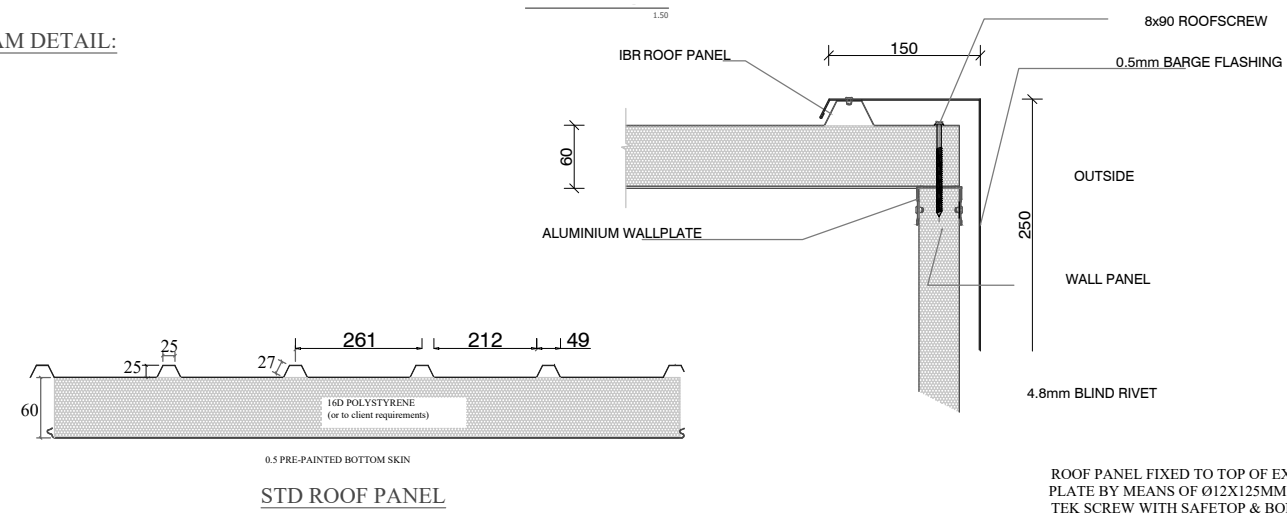
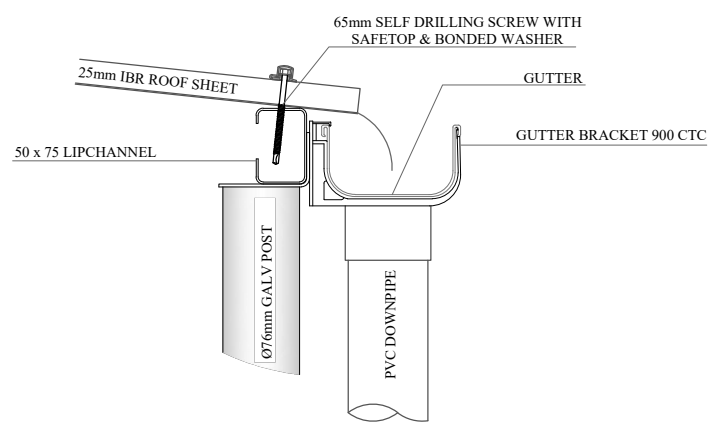
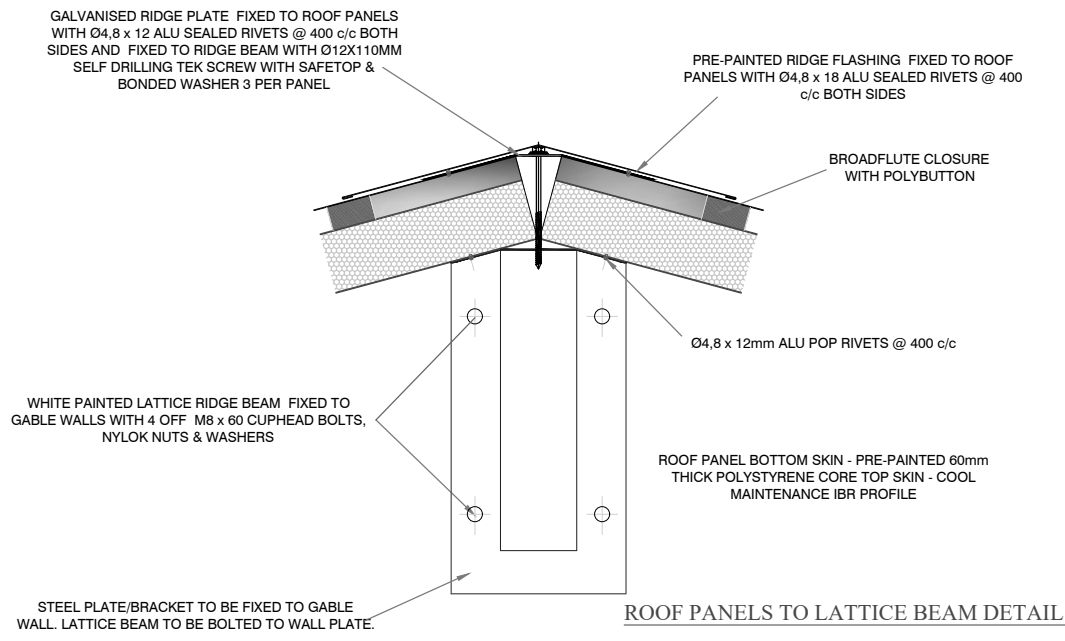

REFERENCE / LOCALITY PLAN

NOTES:
THE USE OF TRADE NAMES ON THIS DRAWING SIMPLY SERVES TO INDICATE A STANDARD ACCEPTABLE TO THE DEPARTMENT, ANY OTHER BRAND MAY BE USED WITH THE PRIOR WRITTEN APPROVAL OF THE PROJECT LEADER.

THE CONTRACTOR MUST WORK FROM FIGURED DIMENSIONS ONLY. CHECK ALL DIMENSIONS AND LEVELS ON SITE BEFORE COMMENCING ANY WORK. ALL DRAWINGS TO BE READ IN CONJUNCTION WITH DETAILS, SCHEDULES, DRAINAGE DRAWINGS, INTERNAL ELEVATIONS, ENGINEERS AND OTHER SPECIALIST'S DRAWINGS.

REFER CONFLICTING INFORMATION TO THE ARCHITECT AND OTHER RESPONSIBLE CONSULTANTS
THE DESIGN ON THIS DRAWING IS THE PROPERTY OF THE PROVINCIAL GOVERNMENT, WESTERN CAPE. BRANCH WORKS AND COPY RIGHT IS RESERVED

REVISIONS

REV.	DESCRIPTION	DATE	BY

ORGANISATION/ DEPARTMENT

Province of the
EASTERN CAPE
EDUCATION
Department of Education
Steve Tshwete Building, Zone 6
Private Bag X0032
Zwelitsha
Eastern Cape

SCHOOL DETAILS

SCHOOL NAME
TYPICAL SUPPLIER DETAILS EXAMPLES
EMIS NUMBER
(EMIS NUMBER)
SCHOOL ADDRESS
(NAME OF SCHOOL AND ADDRESS)

COORDINATES
XXXXXXXXXXXX

LAND VERIFICATION/CONFIRMATION

PROJECT TITLE

PREFABRICATED CLASSROOMS

APPROVALS/ SIGN OFF

PROGRAM MANAGER (DOE)	DATE	SIGN
PROJECT LEADER	DATE	SIGN
SCHOOL GOVERNING BODY	DATE	SIGN
SCHOOL PRINCIPAL	DATE	SIGN

DRAWING TITLE

TYPICAL SUPPLIER DETAILS EXAMPLES

PLANNING	DELIVERY
CAPITAL	MAINTENANCE
DATE	PRINT DATE
November 2021	8/11/2021
PROJECT FILE NO.	DRAWN
	SNK
	CHECKED
	RBAM
	REV NO
DRAWING NO.	SCALE
	1:75, 1:50
	PAPER SIZE
	A1